

Technical Manual

Part 3: Block Wall Design & Construction



6.1 Overview

This section outlines the many factors to be considered when designing autoclaved aerated concrete (AAC) masonry, and provides design tables and charts to assist the designer. The section is broken into four major areas being; Design Background, Design of CSR Hebel AAC Blockwork, Associated CSR Hebel Products, and On-site Considerations.

Design Background

- Applications
- Design Information for AAC Masonry Construction
- Design Considerations
- Construction Considerations

Design of CSR Hebel AAC Blockwork

- Foundations
- Movement
- Robustness
- Compression
- Bending
- Bracing Design
- Roof Hold Down Design

Associated CSR Hebel Products

- Lintels
- 'U' Sections
- Stair Panels

On-site Considerations

- On-site Handling
- Installation

Design Background

6.2 Applications

Introduction

The versatile nature of CSR Hebel enables the products to be successfully used for all types of building construction. CSR Hebel blocks can be used for loadbearing and non-loadbearing walls. The light weight and easy workability of CSR Hebel blocks results in quicker and more economical building.

Housing Construction

Importance factors in masonry construction are summarised in the following extract from the University of Newcastle Research Report No. 085.05. 1993 by Professor A.W. Page.

'Housing systems vary in different parts of Australia, with the masonry sometimes serving as a loadbearing element (as in cavity construction), or simply as a veneer. Masonry can be of several different types, with the masonry units being solid or hollow, and made from fired clay, concrete, calcium silicate, or more recently lightweight autoclaved aerated concrete (AAC). In all cases the masonry behaves as a brittle material with relatively low tensile strength and is therefore prone to cracking. Cracking can be avoided or minimised by ensuring that induced tensile stresses are kept as low as possible, and that the tensile strength of the masonry is as high as possible. These objectives can be achieved by correct design and detailing of the structure, and by maximising the bond strength of the masonry by correct mortar selection and good workmanship.'

The recommended sizes for blockwork in

typical domestic housing and medium density construction are 200mm for external single skin walls, 100mm or 125mm for internal non-load-bearing walls, 150mm for internal load-bearing walls and 125mm where items such as shelving are attached or ceiling height is greater than 3000mm.

Foundation design should be in accordance with Australian Standard AS 2870 Residential Slabs and Footings in Construction. Unless articulated, all walls built in CSR Hebel should be classed as 'full masonry' for the purpose of footing design.

The PowerPanel™ panel has been used as the cladding component of the CSR Hebel Residential Wall System (RWS) which is marketed at the domestic market. PowerPanel™ panels are fixed to a lightweight structural steel or timber support system via horizontal metal furring channels.

The blockwork and CSR Hebel RWS provide thermally superior buildings with low long-term running and maintenance costs coupled with short-term gains resulting from shorter construction time, minimum waste of materials, minimum site preparation for foundations and an enclosed environment for internal fit-out reducing the effect of weather on construction time.

Multi-Residential Construction

Blocks are ideal for constructing shafts for risers. The fire insulating qualities of the AAC blocks provides shaft walls that easily exceed fire resistance level (FRL) requirements. In addition, the lightweight nature of the AAC material, large face area of each block and easy cutting quality – provides the advantage of rapid erection, as the blocks can be easily shaped around the many penetrations.

6.3 Design Information for AAC Masonry Construction

Design Standards and Regulations

Design procedures for the verification of members and structures consisting of CSR Hebel autoclaved aerated concrete (AAC) block products are presented in the Australian Standard AS3700:2001 – Masonry Structures. The procedures cover the topics of:

- Classification of AAC Masonry Construction
- Material Properties
- Robustness
- Durability
- Unreinforced Masonry Design
 - Slenderness
 - Compression Loading
 - Bending
 - Shear
- Method for Compressive Strength Assessment
- Bond Wrench Testing Guidelines

The design information, including charts and tables, presented in the following section is based on the relevant sections of AS3700, where AAC blockwork is specifically included. For **reinforced walls**, a structural engineer shall determine the amount of reinforcement to be installed and reinforcement spacing.

The AAC masonry constructed from CSR Hebel block products is called 'Plain Masonry' and the blocks are masonry units referred to as 'Solid Unit'. The type of solid unit is 'Autoclaved aerated concrete masonry unit' complying with AS/NZS 4455 – Masonry Units and Segment Pavers.

For determining the structural resistance of masonry, the following document is

adopted by reference in the Building Code of Australia:

- AS3700-2001 Masonry Structures; and by association
- AS/NZS4455 Masonry Units and Segmental Pavers

Guarantee and Certification

CSR Hebel is a business of CSR Building Products Limited ABN 55 008 631 356. It is a manufacturer and supplier of CSR Hebel, Autoclaved Aerated Concrete (AAC) products. Because it is a manufacturer and supplier only, CSR Hebel does not employ people qualified as Accredited or Principal Certifiers. CSR Hebel is therefore unable to provide Construction Compliance Certificates or Statements of Compliance.

CSR Hebel does guarantee the products manufactured by itself and the products used in the systems described in CSR Hebel's literature, subject to the terms and conditions of the CSR Hebel Guarantee. CSR Hebel does not however guarantee the components, products or services, such as installation and specialist advice, supplied by others.

CSR Hebel conducts appropriate testing of its products and systems, and sources opinions to determine performance levels. These include structural, fire and acoustic. Testing and opinions are conducted and certified by appropriate specialists in these fields. CSR Hebel can provide copies of test results and opinions presenting the performance characteristics of its products and systems.

When using CSR Hebel products and systems in specific projects, such specialists should be consulted to ensure compliance with the Building Code of Australia and relevant Australian Standards. CSR Hebel can provide a certification for its panel products. For a specific project, an appropriate specialist can provide the certification of the relevant performance criteria of the systems and supporting structure.

Cracking in Masonry

As a result of the low tensile strength and negligible ductility, all forms of masonry construction behave as a brittle material and are therefore prone to cracking. Similar to other forms of masonry, careful consideration at design stage and attention to detail during construction of autoclaved aerated concrete (AAC) masonry can minimise such adverse effects.

It is important to note that the Building Code of Australia is performance based. The performance based approach acknowledges the possibility of cracking and does not consider it a defect so long as the structural resistance and other design requirements are maintained.

Cracking of masonry building elements is often of little consequence, structurally or aesthetically, depending on the wall finishes. The Office of Fair Trading, Guide to Standards and Tolerances (April 1999) identifies cracking of more than 1mm a defect in rendered surfaces. This limit is also specified in AS3700 and AS2870. Cracks up to 1mm, whilst not considered a defect in these documents, may allow water ingress in single skin masonry construction and therefore could be considered a defect under the BCA. This highlights the importance of good coating systems for CSR Hebel blockwork. Coating systems should be able to bridge minor cracking.

Cracking can be due to external effects:

- Foundation and support movement.
- Deformation (shortening, shrinkage, creep, bridging control joints in structure, etc.) in adjacent materials.
- Workmanship.

The material properties of masonry units and their mortars must be taken into consideration when designing and

specifying masonry blockwork to prevent or minimise cracking. AAC differs slightly from clay brick and concrete block masonry so in addition to the general behaviour of masonry, the effect of the following differences must be considered:

- Lower compression capacity.
- Lower tensile strength.
- Lower modulus of rupture.
- Lower coefficients of thermal expansion and contraction and drying shrinkage.
- Larger unit size.
- Laid in thin bed mortar which typically has higher compression capacity than the units.
- Units are autoclaved.
- Dissipates and absorbs moisture from the atmosphere with associated volume change.

Considerations for design and detailing:

- Elements of masonry blockwork must be isolated from movement.
- Control joints.
- Wall restraints.
- The compressive strength of render coatings must not exceed that of the blockwork.
- Use plasterboard linings internally.
- Use flexible coating systems that are able to bridge hairline cracks.
- Apply mesh within the render over areas of high stress.

6.4 Design Considerations

The following are common issues requiring consideration and resolution in the application of AAC masonry to individual projects:

Design Approach

CSR Hebel suggests considering a wall as having top and bottom lateral restraints only (one-way vertical span) and designing the appropriate wall thickness, so that retrofitting or changing the location of the movement joints will not be detrimental to the lateral load capacity of the wall. In determining the appropriate wall thickness, the designer shall consider a range of factors relating to relevant codes and project specific considerations, these factors may include:

- Movement joint location.
- Bracing considerations.
- Vertical (compression) loading.
- Out-of-plane wind/earthquake (lateral) loading.
- Fire Resistance Level (FRL) rating.

Dimensional Layout

To exploit the modular nature of masonry and the tight tolerances of CSR Hebel block products, it is recommended that the designer set out openings to suit a grid which is a multiple of the block length and/or height. This will reduce on-site cutting and speed up the construction process.

Vertical Dimensional Control

The preferred multi-modules are 300, 600 and 1200mm and sub-modules 25, 50 and 75mm. The CSR Hebel block sizes are consistent with these dimensions.

Geometric design of buildings and structures takes place in three dimensions,

on a horizontal and in a vertical plane. The designer as initiator needs to exercise dimensional control by specifying preferred dimensions as far as possible.

The following guide is provided to encourage a unified approach to design. It should not however restrict the use of creative or innovative design.

Vertical Dimensional Control

Ceiling Heights	Door & Window Head Heights	Sill Heights
2400	2200	600
2600	2400	800
2800		1000
		1200

Horizontal Dimensional Control

Door Openings	Clear space between columns for infill walls	Centre to centre spacing of interior columns	Window Openings
900	3000	3000	600
1200	3600	3600	900
	4200	4200	1200
			1800
			2400

Ready Reckoner

Non-Structural Walls

Typically, non-structural internal walls are 100mm thick. It is recommended that the walls be lined both sides with plasterboard sheeting.

Structural Walls

Generally, the minimum recommended wall thickness, is:

- 200mm for external walls, and (other thicknesses are available: 225, 250 & 300mm)
- 150mm for internal walls.

The particular project loading configurations could result in walls that exceed the above minimum requirements.

Foundations

Designed for FULL MASONRY or ARTICULATED FULL MASONRY in accordance with Australian Standard AS2870.

Movement Joints

Movement joints (M.J.) are required to minimise and control cracking in a block wall by breaking the wall into separate masonry panels with points of weakness {articulation joints (A.J.) and control joints (C.J.)}, which locate and allow movement. Refer to Section 6.7.

Joints should be included in all walls, both internal and external.

Free Standing Walls

CSR Hebel walls with returns should be checked for lateral stability. As a rough guide, if a return on a wall is less than 400mm then that end of the wall is without adequate lateral support and requires fixing to a support or bracing. In some buildings where window openings go all the way to ceiling height the intermediate wall may be free standing. These blades should be carefully checked and braced during construction.

Concentrated Loads

For large concentrated loads, such as steel beams or girder trusses, supported on CSR Hebel walls these are to be approved by the project engineer.

Unsupported Walls Lengths

For short lengths of unsupported walls, such as between window openings, without perpendicular cross walls should be avoided. Where possible, such walls should be a minimum of 900mm wide and should be approved by the project engineer for structural adequacy.

Bearing Length

For monolithic loads, such as suspended floor slabs and roof framing, ensure an adequate bearing width, and project engineer to consider the effects of eccentric loading.

Columns

Likewise, monolithic CSR Hebel AAC columns can be used, but should be designed in accordance with AS 3700. Intermediate columns in double garages should be a minimum of 400mm x 300mm to provide adequate seating for lintel beams. It is also recommended that they be constructed using 100mm thick blocks and filled with 200mm x 100mm reinforced concrete to the footing and roof system.

6.5 Construction Considerations

The following are common issues requiring consideration and resolution in the application of AAC masonry to individual projects:

Coatings & Linings

Only coating manufacturer recommended coating systems should be used on CSR Hebel AAC block walls. Ensure coatings are suitable for use on CSR Hebel AAC. Refer to the CSR Hebel Technical Manual Section 9 for further information.

CSR Hebel recommends lining 100mm and 125mm thick internal block walls with plasterboard sheeting.

Bond Breaker Layer

A necessary part of a CSR Hebel AAC block wall is the bond breaker layer, which is installed at the base of the wall between the concrete foundation and the wall. This layer accommodates the different shrinkage rates and differential movement/

displacement of the CSR Hebel AAC blockwork and concrete by allowing localised slip to occur, which helps relieve any build up of stress. Typically, a damp-proof course (DPC) material is used with CSR Hebel AAC block walls to provide a slip plane, as well as prevent rising damp. Walls supporting suspended concrete floors require a suitable slip joint at the interface, such as two layers of greased, galvanised iron sheet. Refer to Section 6.18 for further details.

Damp Proof Course

A damp-proof course (DPC) membrane is recommended for use with CSR Hebel walls, to prevent damp rising in masonry.

Workmanship

Ensure that all perpends are completely filled. Ensure all bed joints and perpend joints are approximately 2-3mm thick. Refer to the 'Installation Section' 6.17, for further details.

Timber or Steel Floor and Roof Systems

Flooring

If timber floor joists, timber or particle board flooring is used in conjunction with CSR Hebel products, a minimum 10mm gap must be left at either end where the joists intersect with CSR Hebel products to allow for potential timber movement. Timber bearers and joists must sit on a timber plate.

Roofing

Timber roof design must comply with the forces for the intended design wind loading category. Non conforming roof designs should be checked by a practising **structural engineer** to ensure that excessive lateral forces are not transmitted into the rigid supporting block walls. The use of bond beams should be included when 'cathedral' type ceilings are used or when roof spreading may be a

problem.

Movement Joints (M.J.)

Attention should be given to ensuring that these joints are kept free of all debris and mortar, and connectors installed in accordance with manufacturer's recommendations. Importantly, in no circumstances should a movement joint be rendered across. Ensure specified backing rod and sealant are installed in accordance with manufacturer's recommendations.

Hebel Adhesive

The Hebel Adhesive should be prepared in accordance with the instructions on the packaging. Importantly, the adhesive should not be retempered as this will have a detrimental affect on the bond strength.

Hebel Highbuild

The Hebel Highbuild render should be prepared in accordance with the instructions on the packaging. Importantly, the render should not be retempered as this will reduce the strength and affect the qualities of the render.

Chasing

Refer to Section 5 of Fire Design in this technical manual.

Steel Beams

When steel beams are used in conjunction with CSR Hebel AAC construction, the end bearing should be carefully checked. The principles of AS3700 can be adopted for the bearing under a point load, however as a guide for design, a figure of 0.5MPa is conservative for local crushing under the beam. If high loads are involved, bearing plates and steel SHS sections can be used. These should be designed by a practising **structural engineer**.

Design for CSR Hebel Blockwork

6.6 Foundations

The selection of the foundation type for use with CSR Hebel blockwork is based on AS2870, 'Residential Slabs and Footings'.

This standard covers the selection of footing designs for the usual range of site conditions, i.e. soil types and slopes. Where unusual site or load conditions are encountered, advice should be obtained from a practicing Structural Engineer. It is recommended that a practicing **structural engineer** is consulted concerning the application of AS 2870 to any particular building construction or site.

The approach to foundation design using AS2870 is to first classify the foundation soil, then assess the topography and select the appropriate footing design to be used. Following is a guide to this foundation design approach. The structural engineer should approve this approach before adopting.

Step One: Classify the Foundation Soil

The foundation soil provides support for the building. If there is reactive or expansive clay in the soil, it may swell on wetting and shrink on drying, causing foundation movement to an extent that may cause cracking of the walls.

The appropriate soil classification for a particular site may be obtained from the following sources:

- Advice from a Geotechnical Engineer.
- Local Council or other local authority for their information on the locality.
- A local Builder or Engineer familiar with the site classification.

- Site testing in accordance with relevant standards.

Step Two: Assess the Topography

Typical topographical items which should be considered in a site inspection are:

- Is the site level or sloping? If any part of the foundation is on fill more than 50 mm deep the site is classified as sloping.
- What will be the maximum depth of cut? A retaining wall will be required for cuts deeper than 600mm within 2m of the building.
- Can surface water be diverted away from the building? Surface gutters and/or agricultural pipes may be required.
- Will it be necessary to fill any part of the site to provide support for the foundations? Fill must be suitably compacted in layers. Fill containing clay will cause many problems. It is preferable to import sandy or granular fill.
- Will fill require retaining? Soil filling can be compacted to a slope not steeper than 1:2 without the need for a retaining wall.

Note that for sloping sites it may be necessary to retain fill under the slab by using deep edge beams.

Step Three: AS2870 Site Classifications

Class A

Most rock or sand sites, with little or no ground movement from soil moisture changes.

Class S

Slightly reactive clay sites with only slight ground movement.

Class M

Moderately expansive soils such as certain types of clays or silts.

Classes H and E

Highly reactive clays that exhibit substantial and extreme movement due to moisture changes.

Class P

Problem sites such as soft clays and silts, loose sands, filled sites, landslips. Reactive sites subject to abnormal moisture conditions.

Where detailed knowledge of the underlying soil profile is not known, classification of the site can be determined by appropriate testing using soil shrinkage indices appropriate to the soil profile of the site and suction change profiles, which represent the design moisture content to determine the characteristic surface movement, y_s .

Surface Movement	Soil Classification
0 mm < y_s < 20 mm	S
20mm < y_s < 40 mm	M
40mm < y_s < 70 mm	H
y_s > 70 mm	E

Step Four: Select the Footing Type

Standard designs for footing systems should be selected using Section 3 of AS2870.

It is recommended that all walls constructed using CSR Hebel blocks are classified as full masonry. However, unlike clay brick walls, the integrity of a CSR Hebel wall is more critical because of the 'flush type' finish of the coatings used. This requires a stiff footing system when used as either a masonry veneer or a single skin. Unless articulated, all walls built in CSR Hebel should be classified as full masonry for the purpose of footing selection.

The wall classification may be changed to articulated full masonry where movement joints are incorporated in the external and internal walls at no more than 6 m spacing.

Example 1

For a single skin full masonry (non-articulated) CSR Hebel building on Class M soil, using a stiffened raft on a level site, from Figure 3.1:

Refer to Table in Figure 3.1 of AS2870.

Depth of edge and internal beams: 800mm

Maximum spacing of internal beams: 4m

Reinforcing in beam: 3 – N16

Slab fabric: SL92

Example 2

For a single skin articulated CSR Hebel building on Class M soil, using a stiffened raft on a level site:

Refer to Table in Figure 3.1 of AS2870.

Depth of edge and internal beams: 500mm

Maximum spacing of internal beams: 4m

Reinforcing in beam: 3 – L12TM

Slab fabric: SL82 – SL92

It is recommended that a practicing Structural Engineer is consulted concerning the application of AS2870 to any particular building construction or site.

6.7 Movement Joints (M.J.)

During the life cycle of a building, the building and the materials that it is constructed from will move. These movements are due to many factors working together or individually, such as foundation movement (shrinkage and swelling), thermal expansion and contraction, differential movements between materials, climate and soil condition. This movement, unless relieved or accommodated for, will induce stress in the materials, which may be relieved in the form of cracking. To accommodate these movements and relieve any induced stresses, which could potentially crack the wall, movement joints (vertical gaps) shall be installed. There are two categories of joints:

- **Articulation joints (A.J.)** are provided to relieve induced stresses due to foundation movement. The joints make the walls more flexible by breaking the wall into a series of small panels, which is especially required on reactive ground conditions (clay, peat). Differential movement between the AAC blockwork and adjacent structural elements need to be accommodated with articulation joints, such as blockwork infill between the structural frame.
- **Control joints (C.J.)**, (one type is an expansion joint), are provided to relieve the induced stresses resulting from thermal expansion or contraction of the AAC, or differential movement between the AAC and another material or structure, such as abutting walls or columns of concrete or brickwork. Control joints can delineate coating shrinkage breaks. A joint may perform the function of either an articulation joint, or control joint, or both.

IMPORTANT: There are restrictions provided to the maximum length of wall:

- 6 metres maximum for continuous runs of walls.

- When measuring the 6 metre run of wall, the measurement continues around corners till the end of the wall or a movement joint.

Additionally, the BCA presents the following requirements for articulation joints in unreinforced masonry walls, which is applicable for AAC masonry construction:

- “b) Articulation joints must have a width not less than 10mm and be provided:
- i. in straight, continuous walls having no openings, at not more than 6m centres and not closer than the height of the wall away from corners; and
 - ii. where the height of the wall changes by more than 20% at the position of change in height; and
 - iii. where openings more than 900x900mm occur, at more than 5m centres, and positioned in line with one edge of the opening; and
 - iv. where walls change in thickness; and
 - v. at control or construction joints in the footing slabs; and
 - vi. at junctions of walls constructed of different masonry materials; and
 - vii. at deep chases (rebates) for service pipes.”

CSR Hebel recommends that movement joints be provided in AAC masonry construction for all site soil classifications.

For further information refer to the Cement Concrete and Aggregates Australia, Technical Note - Joints in Concrete Buildings through website: www.concrete.net.au

The project architect and engineer shall be responsible for determining the optimum location of movement joints, as their location is dependent on a variety of factors including most importantly the structural stability and bracing requirements of the building (see Table 6.1).

Table 6.1: Maximum Joint Spacings in Block Walls

Wall/Footing Design	Joint Spacing
Articulated	Specified by Structural Engineer
Non-Articulated	6m max.

Areas to be considered, but not limited to, include:

Long or short walls tied to each end with substantial, rigid return walls.

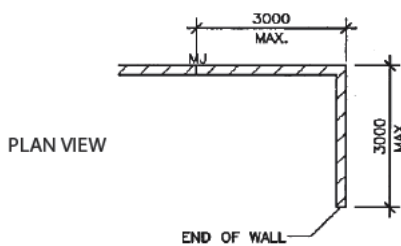

Adjacent to openings.

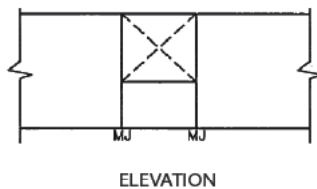
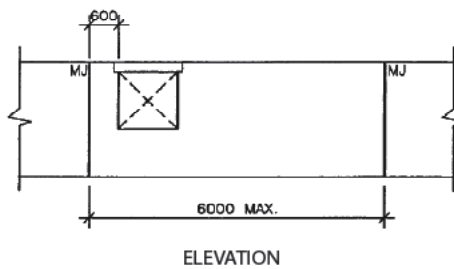

Adjacent to small openings in long walls.
Walls built in dissimilar materials.

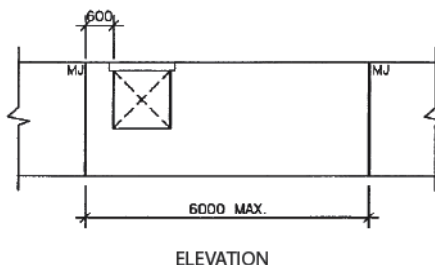

Change in wall thickness or junction of loadbearing and non-loadbearing walls.

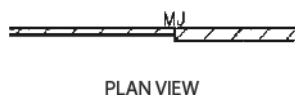

Geometrical change in wall height, i.e., single storey to two storey walls.



Locations or junctions of different foundation types and steps in foundations.

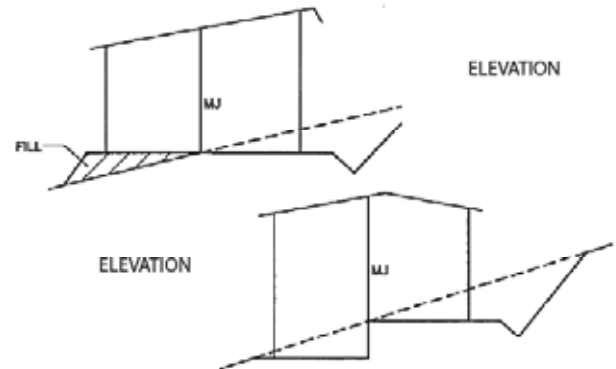

Walls built in dissimilar materials.

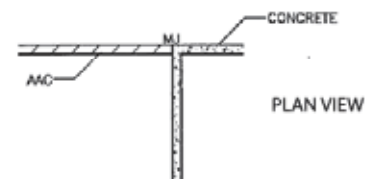

Unless otherwise designed by a structural engineer, movement joints require shear connectors placed across the joints to maintain stability of the walls under lateral loads. Maximum vertical spacing of connectors is 600mm. Approval of the connector spacing shall be provided by the appropriate structural engineer. Refer to Section 6.18 for Construction Details and Section 8 for Fixing Capacities of this manual; and Section 3 of the NZ Addendum.

Attention should be given to ensuring that these joints are kept free of all debris and mortar, and connectors installed in accordance with manufacturer's recommendations.

Importantly, in no circumstances should a movement joint be rendered across.

6.8 Robustness Limits

AS 3700 (Clause 4.6) requires that members must be designed for robustness. This provides practical limits to slenderness for walls and piers and must be applied in addition to all other design requirements. Checking robustness is not a substitute for proper engineering design. Each of the various loading conditions (compression, flexure, fire, shear etc.) must be checked and designed for as appropriate.

The robustness limits are expressed in AS3700 as limiting values of coefficients C_v and C_h , as shown in Table 6.2 for unreinforced walls and piers.

Table 6.2: Robustness Coefficients
(from AS3700: Table 4.2)

Conditions at the Top & Bottom	C_v
Free top	6
Load other than a concrete slab	27
Loaded by a concrete slab	36
Isolated pier	13.5
Conditions on the Vertical Sides	C_h
One edge supported	12
Both edges supported	36

The coefficients shown in Table 6.2 and the expressions for slenderness ratio in AS 3700 Section 4.6.2 have been used to calculate charts for various support and loading conditions. These charts are intended for single leaf walls only. Rotational restraint applied to an edge of a wall gives no enhancement to robustness and all edge supports are therefore assumed to be simple supports. Each chart is labelled for the relevant loading type and shows an icon to indicate the lateral support conditions. Separate lines are shown on each chart for a range of block thickness from 75 mm to 300 mm, where applicable.

The length and height of the wall are clear dimensions between supports or edges in all cases. Where a wall has a door or window opening, the edge of the opening must be considered as a free edge to the wall for its full height, unless a stiffening mullion is specifically designed to support the edge. The robustness of the wall is therefore checked using the length of wall between the lateral support or free edge and the edge of the opening, using the appropriate chart for a wall with one or both vertical edges free. The same applies to a control joint, which is always treated as a free edge to the wall and it should also be applied in a case where a substantial vertical chase is made in the wall. Control joints should be placed in walls at appropriate spacings as set out in Section 6.7.

Chart RB1 and Chart RB2 apply to walls with four sides supported. Chart RB3, Chart RB4 and Chart RB7 apply to walls with three edges supported, having either the top or a vertical side free. Chart RB5, Chart RB6 and Chart RB8 apply to walls with two edges supported (either the top and bottom or the bottom and one side only). In the case of Chart RB5 and Chart RB6 the transitions to the robustness limits for isolated piers are shown. AS3700 Clause 1.5.2.27 requires that a wall must be considered as an isolated pier when the height-to-width ratio is greater than or equal to five.

Chart RB1: Walls with four sides laterally Supported – Load Other than a Concrete Slab or No Load

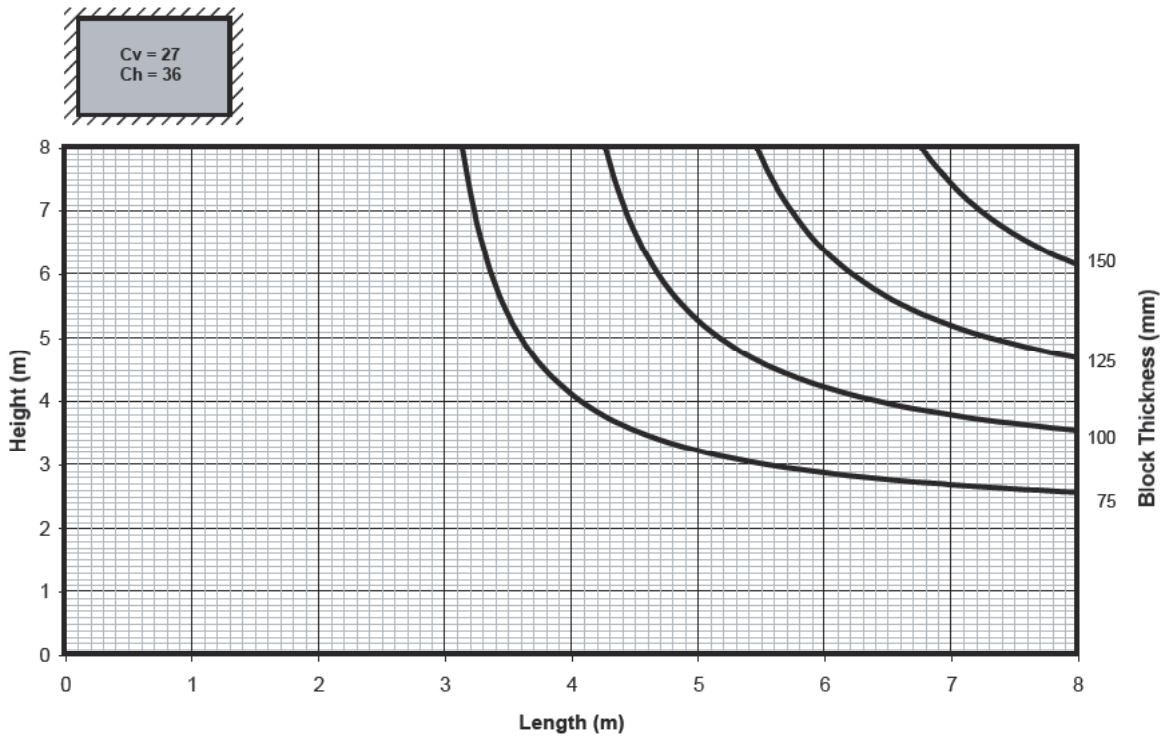

Chart RB2: Walls with four sides laterally Supported – Load by a Concrete Slab

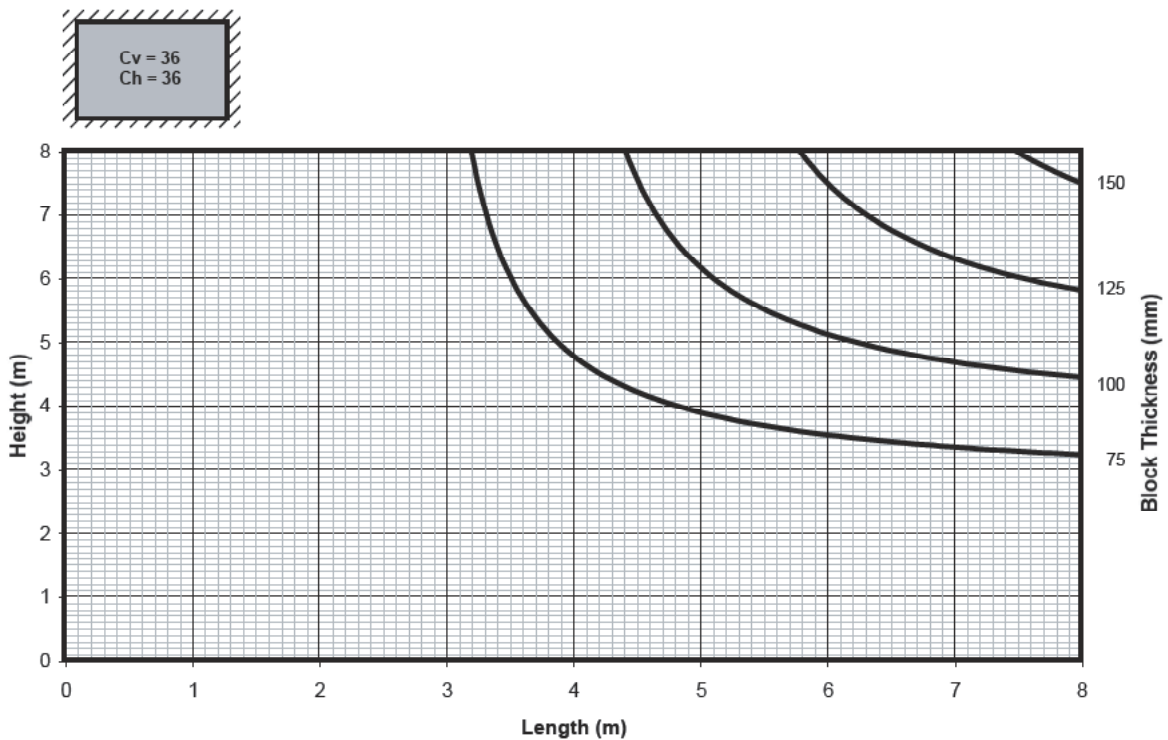

Chart RB3: Walls with one sides free – Load other then a Concrete Slab or No Load

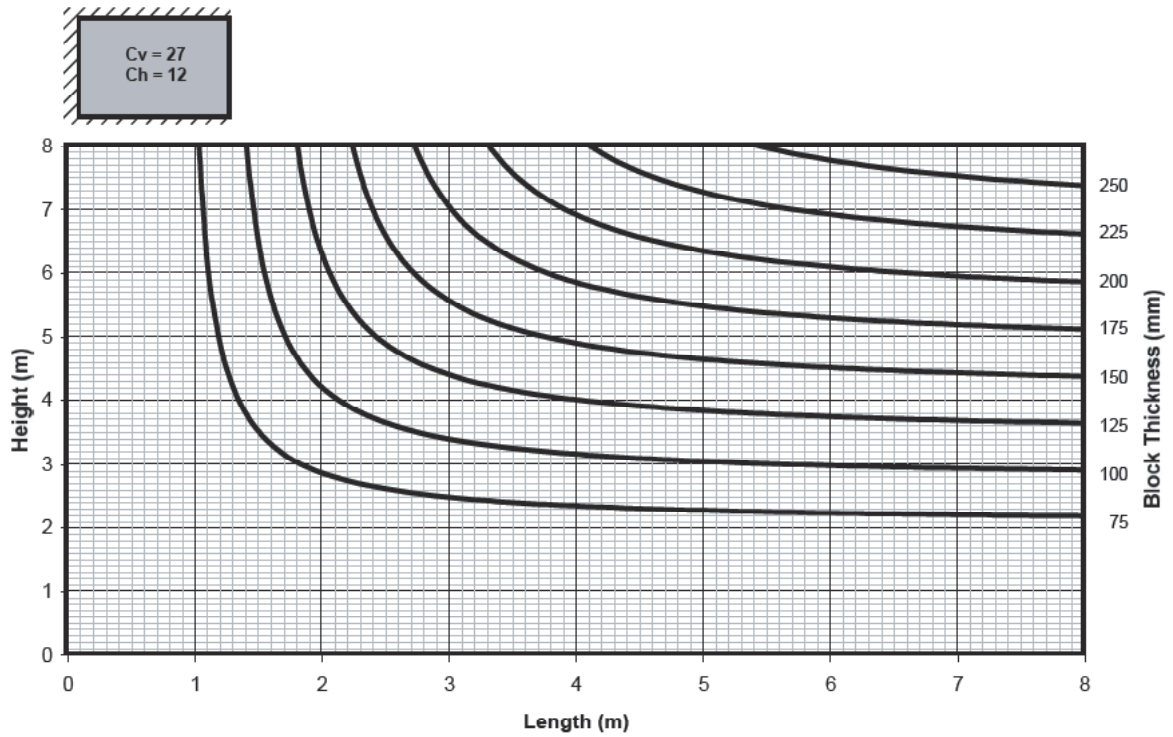

Chart RB4: Walls with one sides free – Load with a Concrete Slab

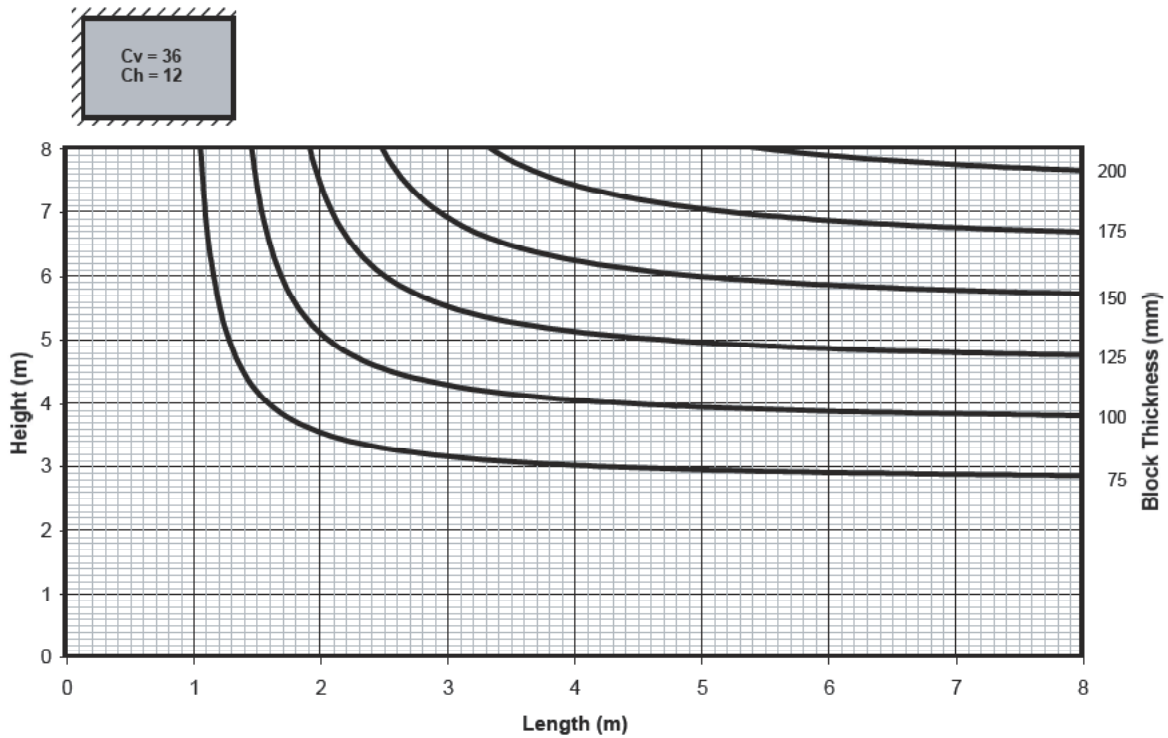

Chart RB5: Walls spanning top to bottom – Loaded other than a concrete slab or no load

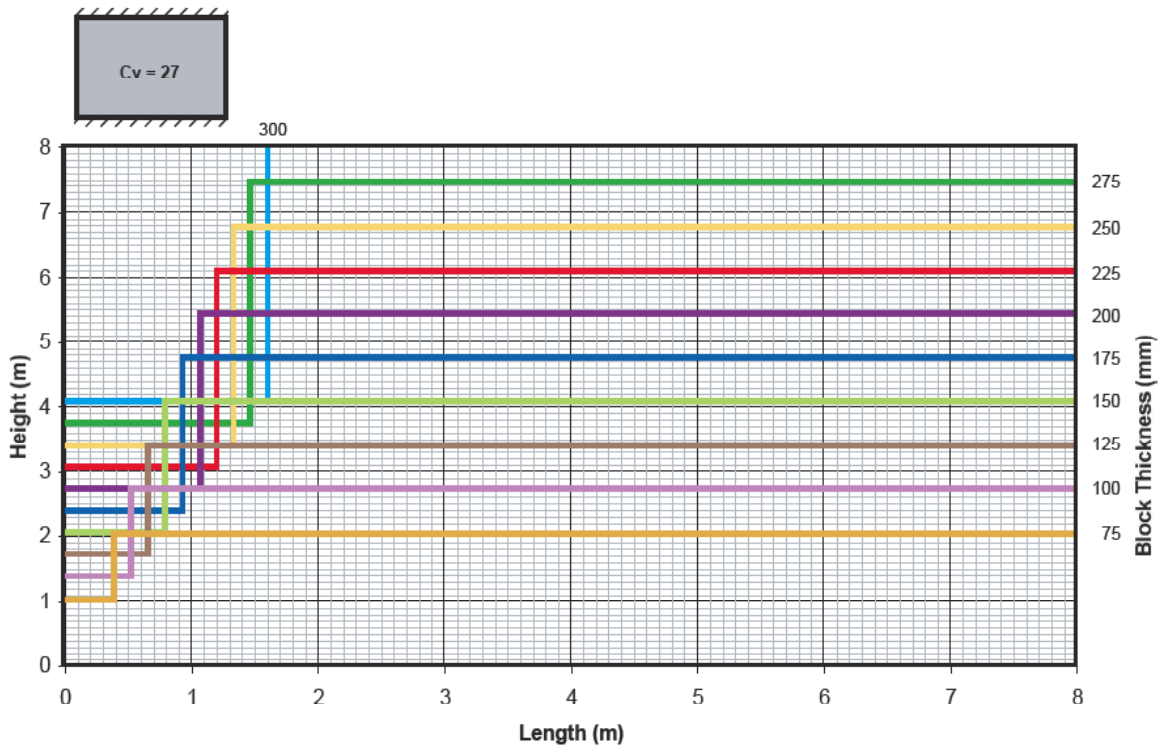
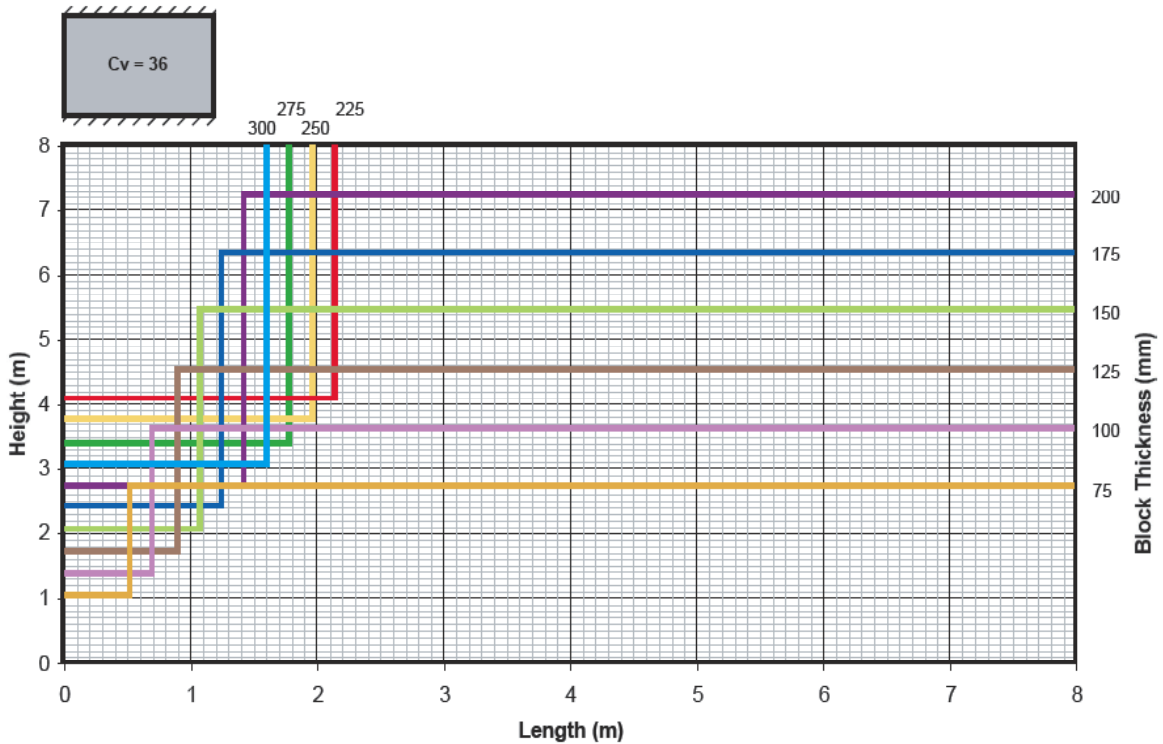

Chart RB6: Walls spanning top to bottom – Loaded by concrete slab



Section 6

Chart RB7: Walls with top free and both side laterally supported

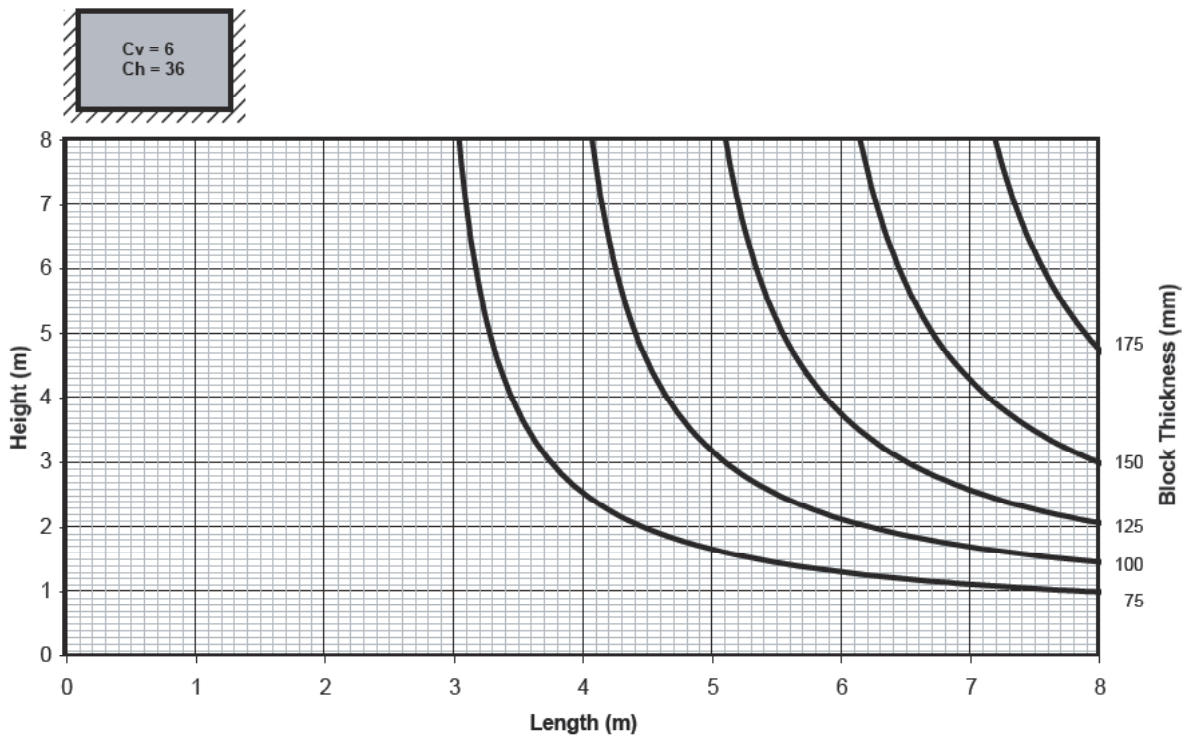
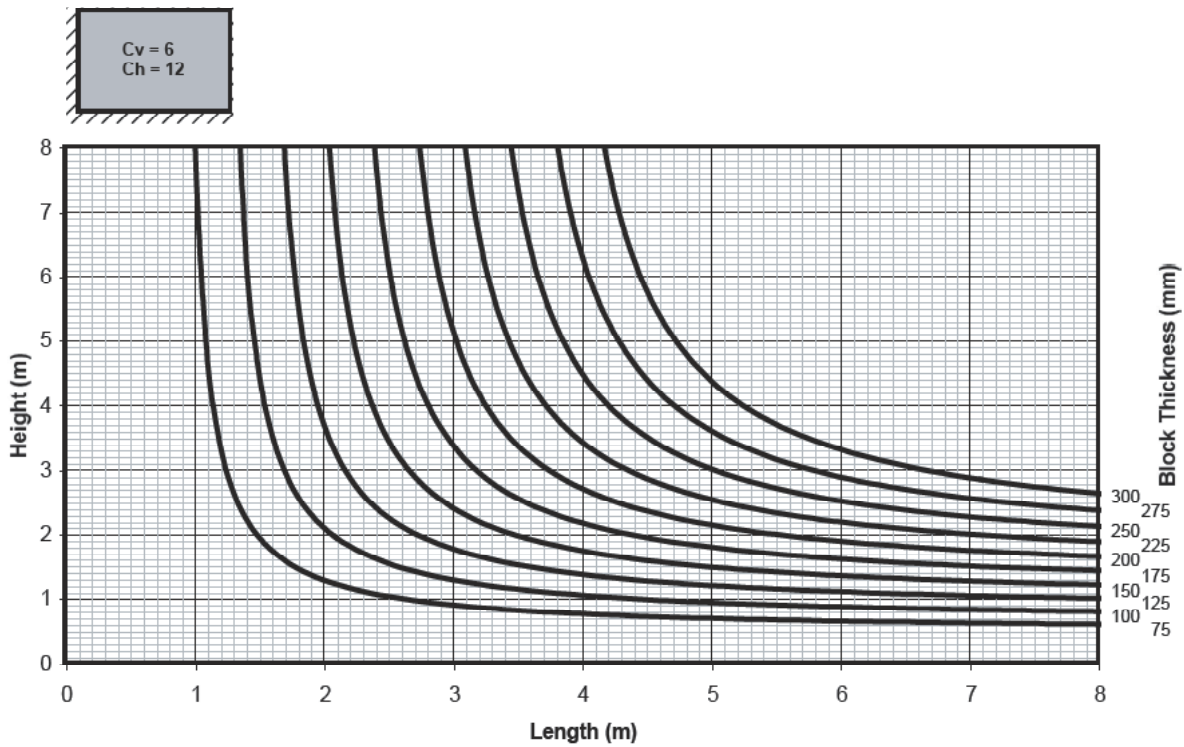

Chart RB8: Walls with one side and top free



6.9 Design for Compression

The capacity of a member under compression loading depends upon the cross-sectional properties, compressive strength of the material, slenderness of the member and the eccentricity of loading at the ends. End eccentricity is determined primarily by the type of loading (roof, floor etc.) and the relative magnitude of any bending moments imposed at the ends in conjunction with the vertical loading.

AS3700 considers that there is no mutual support between the leaves of a cavity wall under compression loading and consequently these charts apply equally to single leaf walls and the separate leaves of cavity walls. No distinction is made between simple supports and those where there is continuity or another possible source of rotational restraint.

Walls can be designed for compression using the rules in AS3700 Clause 7.3, which provides two separate approaches: design by simple rules; and design by refined calculation. The former is sufficient for most cases and has been used as the basis for design in this manual.

Two loading cases are considered here:

1. Loading by a concrete slab supported on the wall. This is treated according to the AS3700 rules for slab loading.
2. Loading by CSR Hebel floor panels supported on the wall. This case is treated according to the AS3700 rules for loading other than a concrete slab. This loading condition would also apply for roof loads supported on the wall.

AS3700 caters for various support conditions by the use of slenderness coefficients a_v and a_h as shown in Table 6.3.

**Table 6.3: Slenderness Coefficients
(from AS3700 Clause 7.3.3.3)**

Support Conditions at the Top and Bottom	a_v
Lateral support on top and bottom	1
Lateral support at bottom only	2.5
Support Conditions at the Sides	a_h
Lateral support on both vertical edges	1
Lateral support on one vertical edge	2.5

The coefficients shown in Table 6.3 and the expressions for slenderness ratio in AS3700 Clause 7.3.3.3 have been used to generate design charts for various loading and support conditions. A capacity reduction factor of 0.45 (AS3700 Table 4.1) and the material properties shown in Section 2 have been used.

Sets of charts are given for both the CSR Hebel Thermoblok and Sonoblok products. Each chart is labelled for the AAC type, wall height and relevant loading case, and shows an icon to indicate the lateral support conditions. Separate lines are shown on the charts for block thicknesses from 125mm to 300mm.

The length and height of the wall are clear dimensions between supports or free edges in all cases. Where a wall has a door or window opening, the edge of the opening must be considered as a free edge to the wall for its full height, unless a stiffening mullion is specifically designed to support the edge. The compressive load capacity of the wall is therefore checked for the length of wall between the lateral support and the edge of the opening, using the appropriate chart for a wall with one or both vertical edges free. For design purposes, a control joint or substantial vertical chase should also be considered a free edge. Control joints should be designated by the structural engineer. Section 6.7 presents guidelines on appropriate control joint spacings.

To use the charts, the factored compression load should be determined in accordance with the relevant Australian standard and compared with the load capacity given by the relevant chart for the block type, height, loading/support configuration and block thickness. Either the load capacity can be used to derive a limiting length or the length can be used to derive a load capacity.

The appropriate chart for any particular set of conditions can be found from Table 6.4. The charts provide for the design of walls with heights up to 3m.

Table 6.4 Key to Design Charts

CSR Hebel Floor Panel Over.				
Wall Height (m)	Thermoblok		Sonoblok	
	Four Edges Laterally Supported	One Vertical Edge Free	Four Edges Laterally Supported	One Vertical Edge Free
2.4	Chart CP1	Chart CP2	Chart CP3	Chart CP4
2.7	Chart CP5	Chart CP6	Chart CP7	Chart CP8
3.0	Chart CP9	Chart CP10	Chart CP11	Chart CP12
Concrete Slab Over.				
Wall Height (m)	Thermoblok		Sonoblok	
	Four Edges Laterally Supported	One Vertical Edge Free	Four Edges Laterally Supported	One Vertical Edge Free
2.4	Chart CP13	Chart CP14	Chart CP15	Chart CP16
2.7	Chart CP17	Chart CP18	Chart CP19	Chart CP20
3.0	Chart CP21	Chart CP22	Chart CP23	Chart CP24

Chart CP1 : Thermoblok Walls Up To 2.4m High with Four Edges Laterally Supported and Loaded by a Hebel Floor

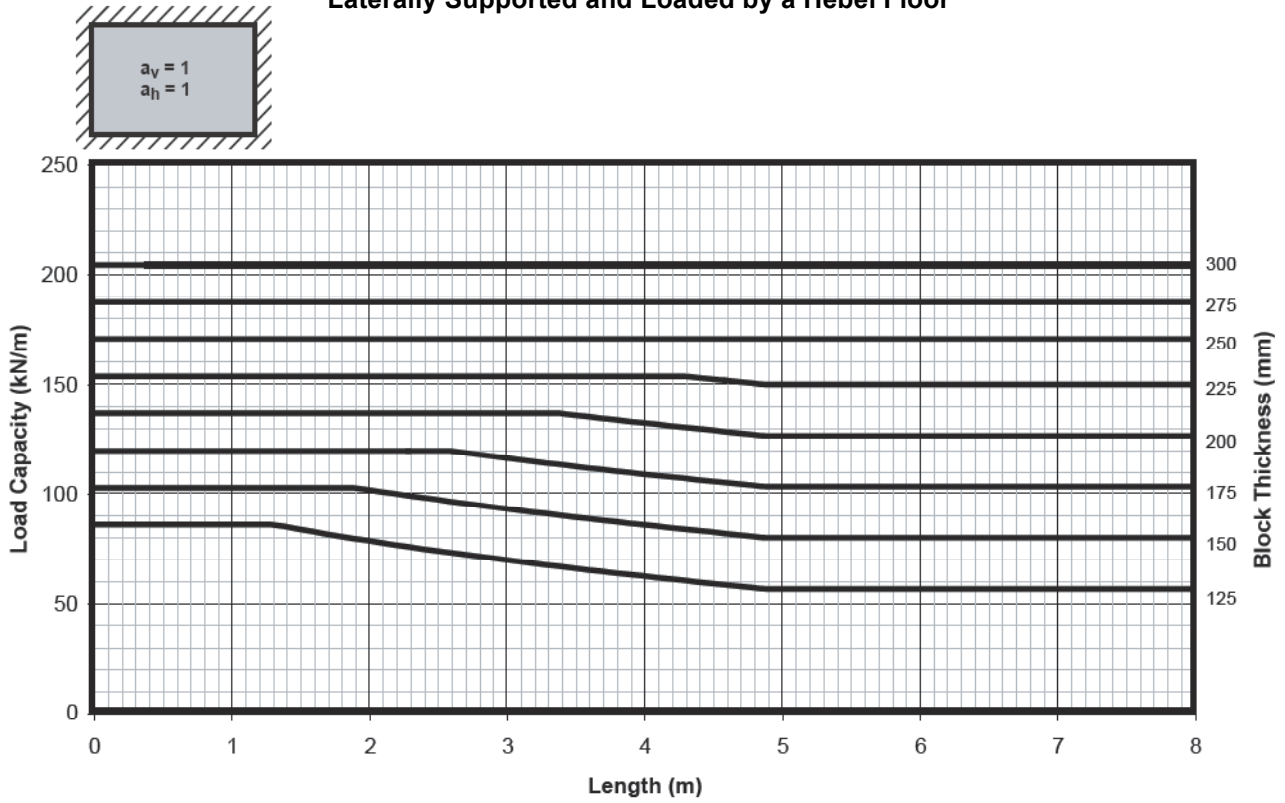

Chart CP2: Thermoblok Walls Up To 2.4m High with One Side Free and Loaded by a Hebel Floor

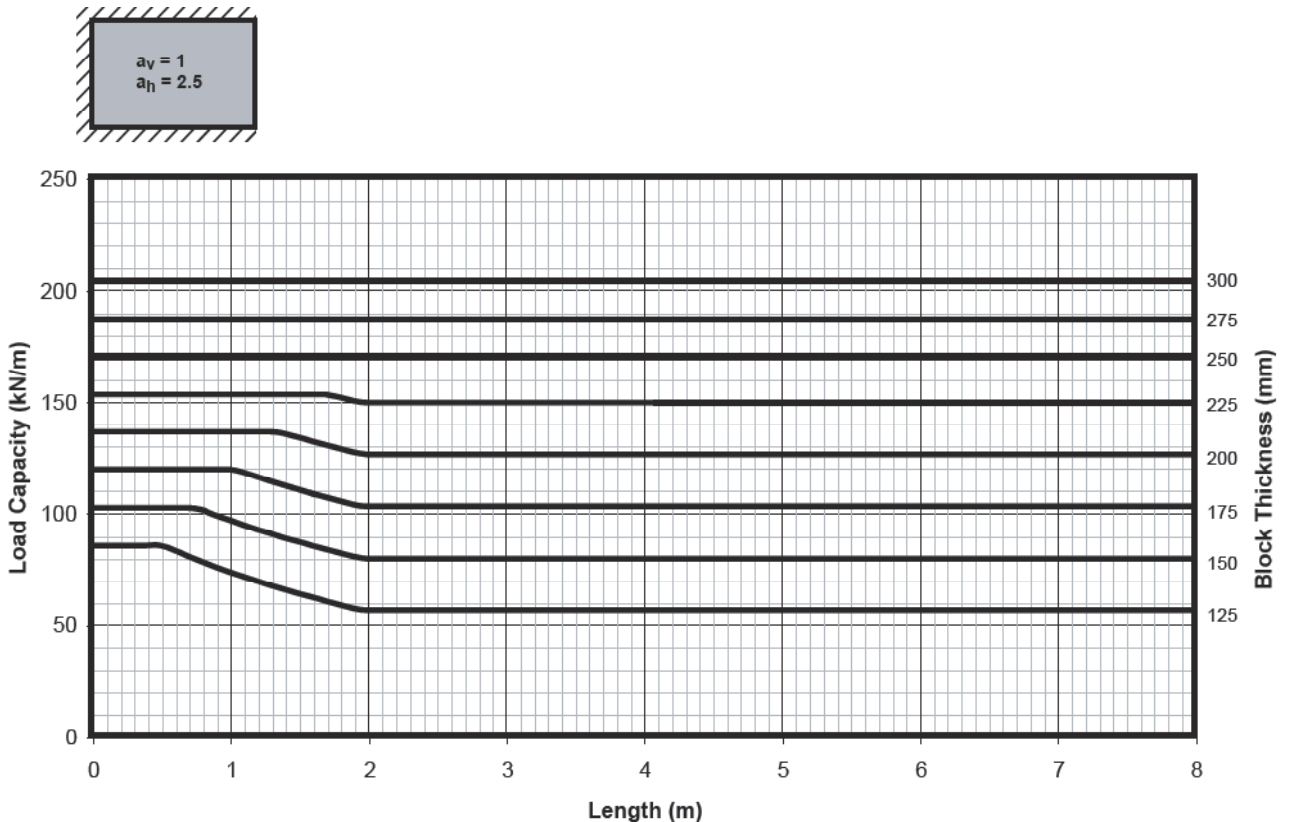

Chart CP3: Sonoblok Walls Up To 2.4m High with Four Edges Laterally Supported and Loaded by a Hebel Floor

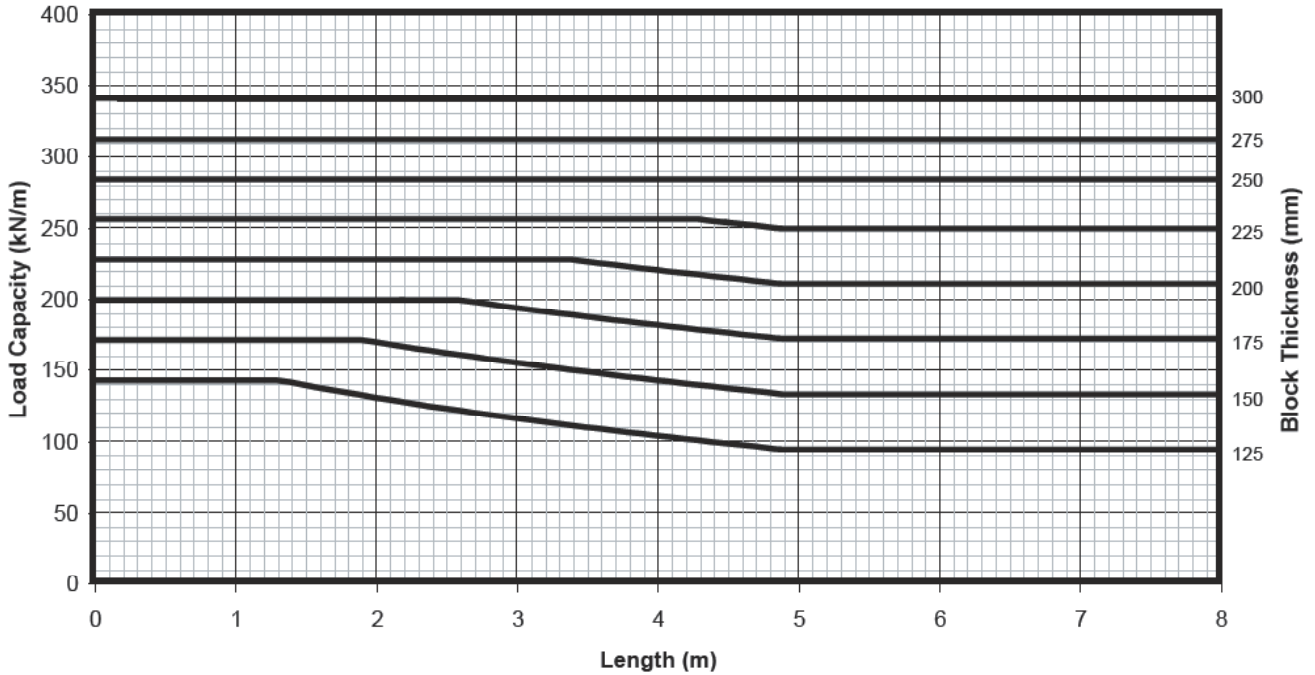
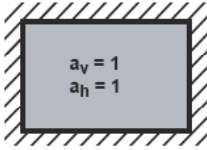

Chart CP4: Sonoblok Walls Up To 2.4m High with One Side Free and Loaded by a Hebel Floor

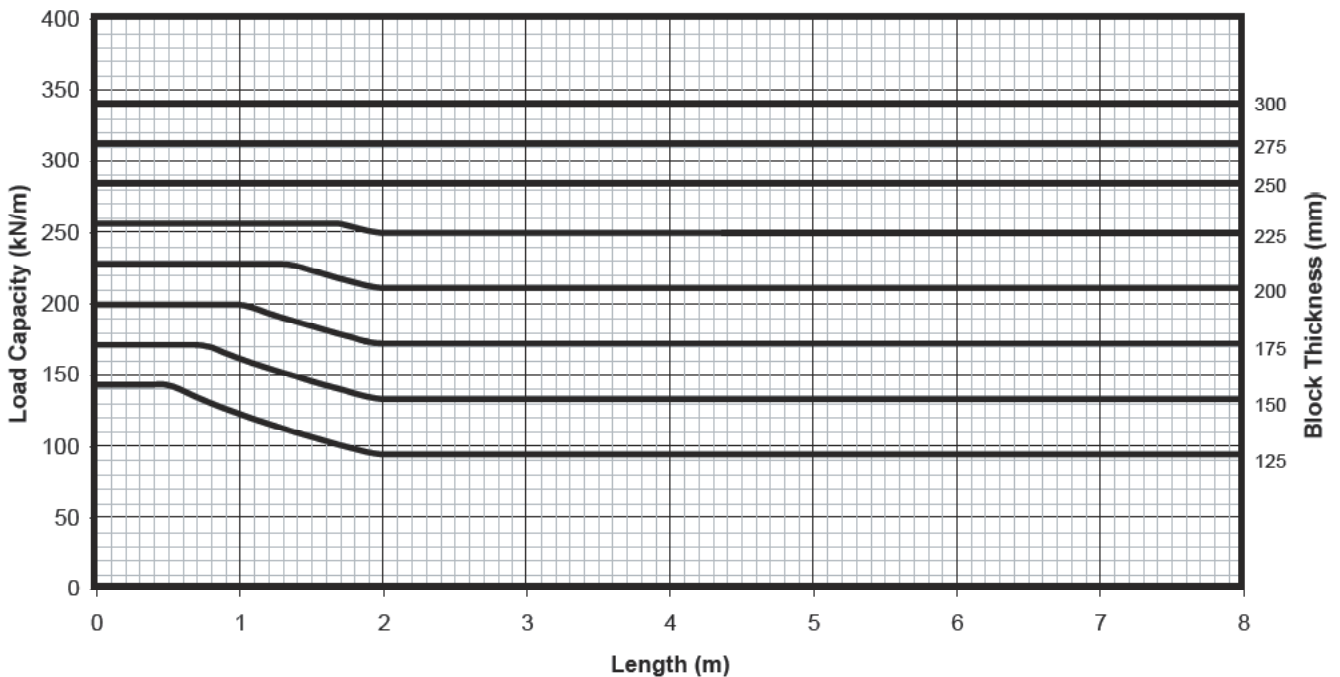
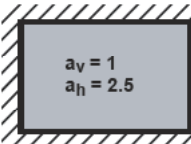

Chart CP5: Thermoblok Walls Up To 2.7m High with Four Edges Laterally Supported and Loaded by a Hebel Floor

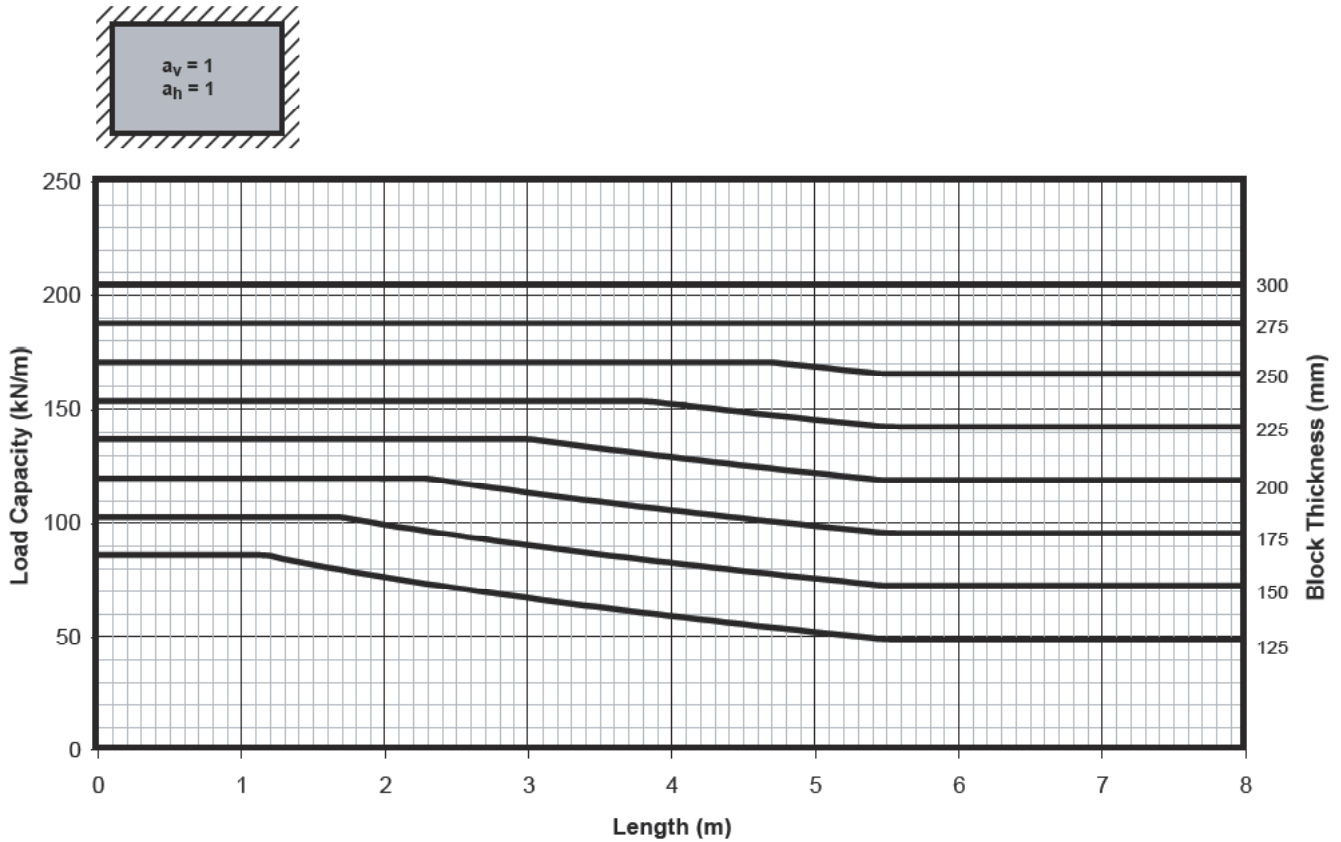

Chart CP6: Thermoblok Walls Up To 2.7m High with One Side Free and Loaded by a Hebel Floor

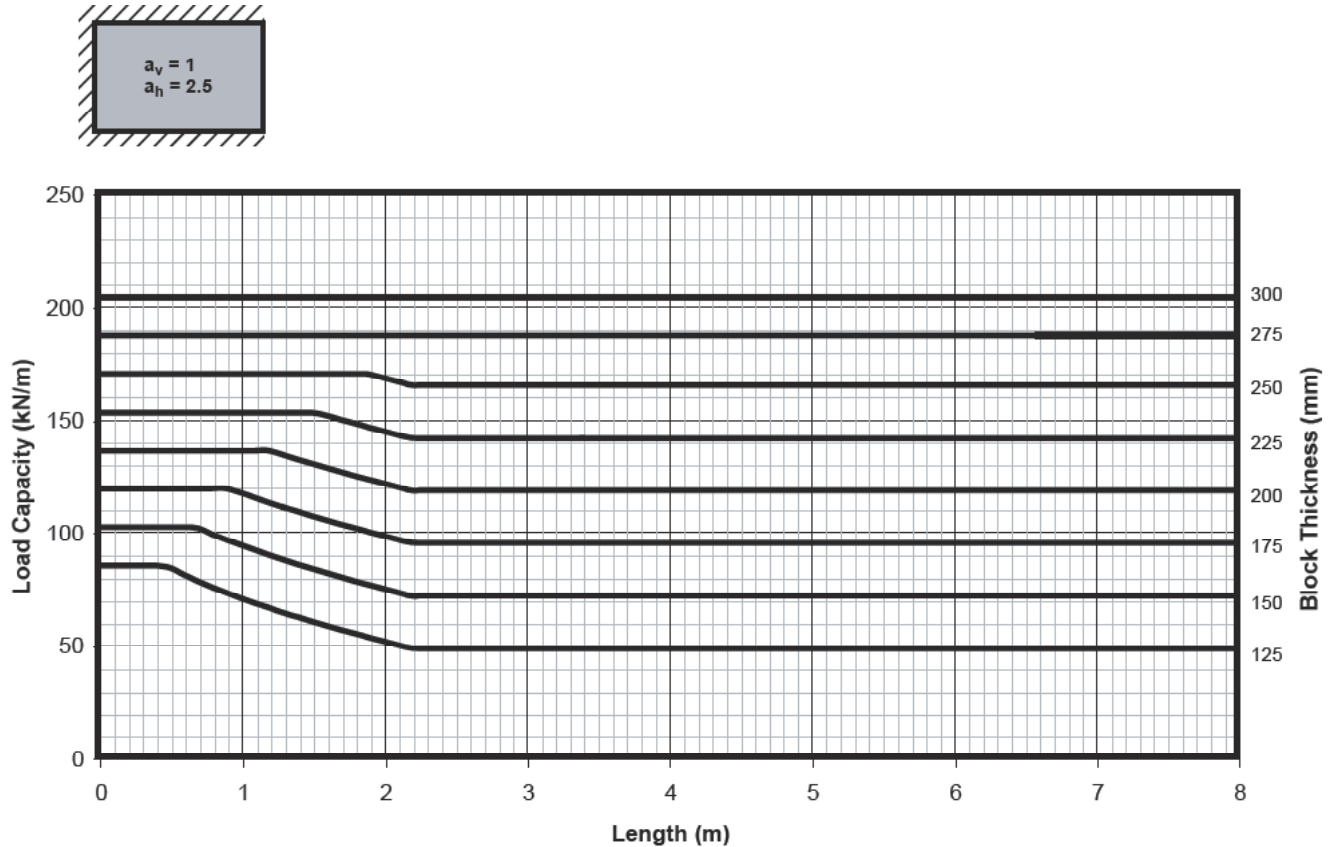

Chart CP7: Sonoblok Walls Up To 2.7m High with Four Edges Laterally Supported and Loaded by a Hebel Floor

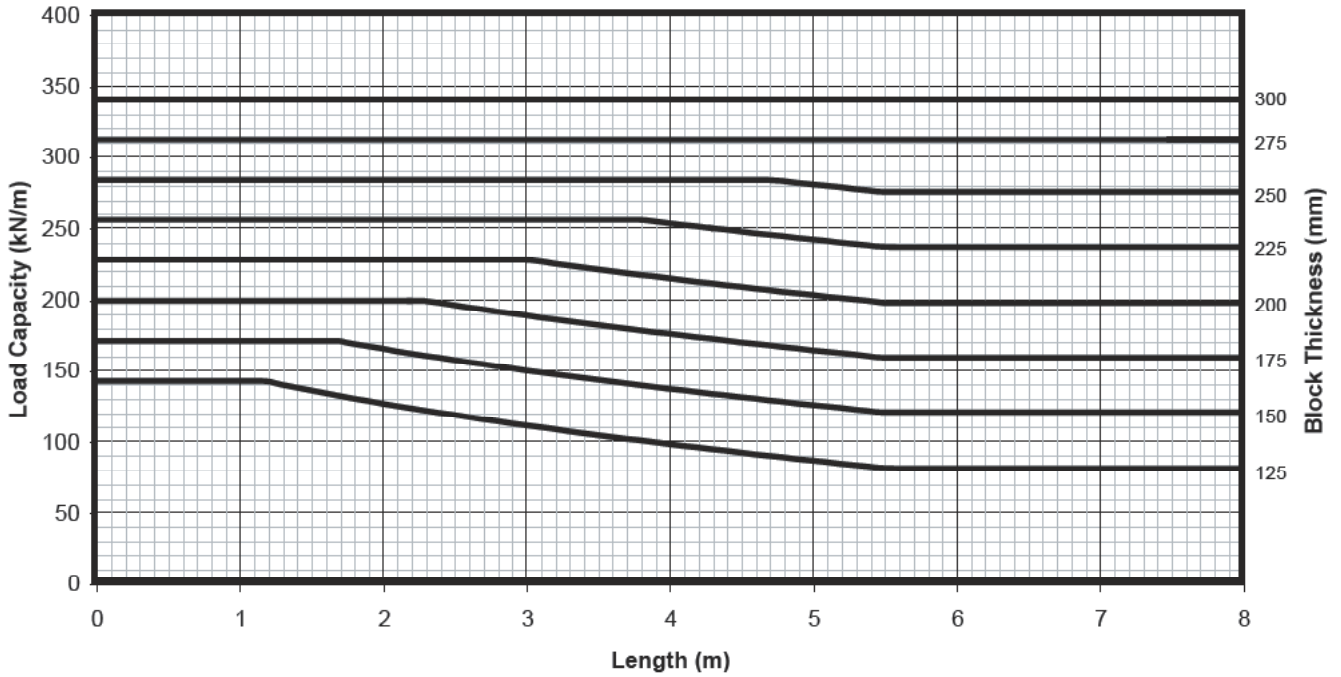
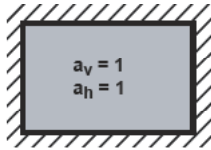

Chart CP8: Sonoblok Walls Up To 2.7m High with One Side Free and Loaded by a Hebel Floor

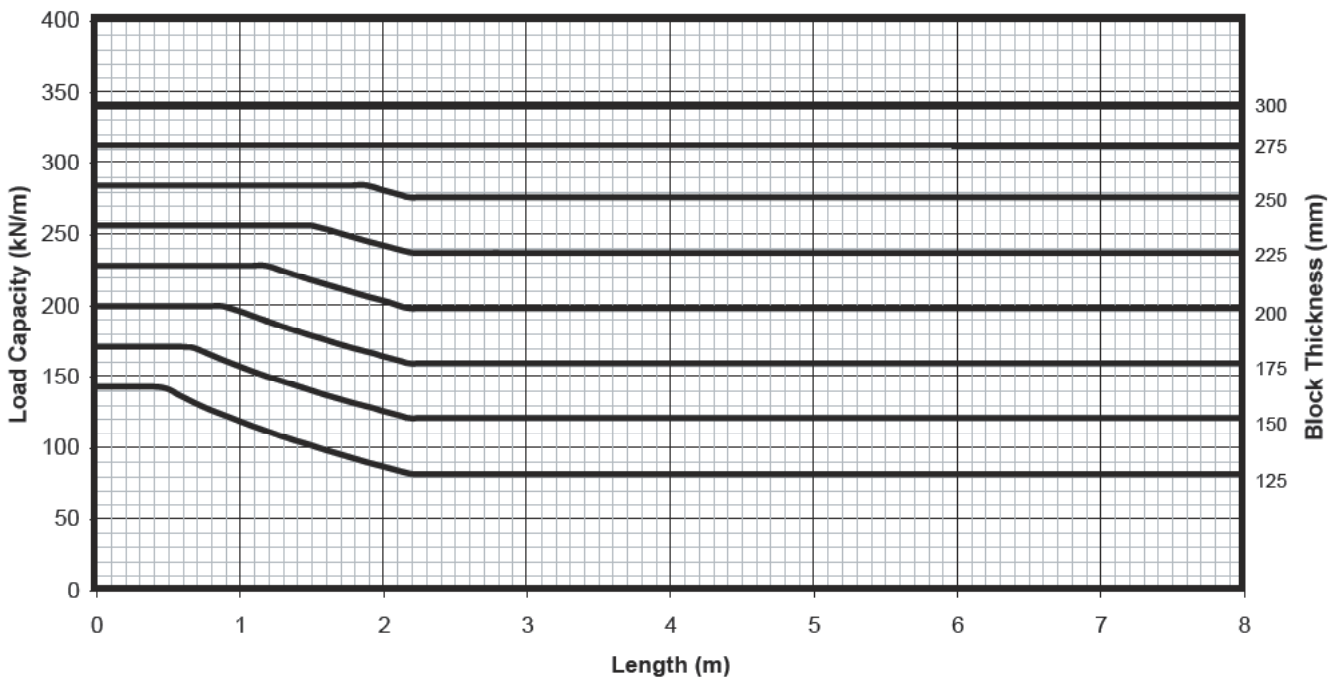
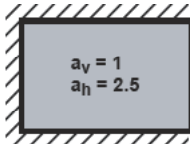

Chart CP9: Thermoblok Walls Up To 3.0m High with Four Edges Laterally Supported and Loaded by a Hebel Floor

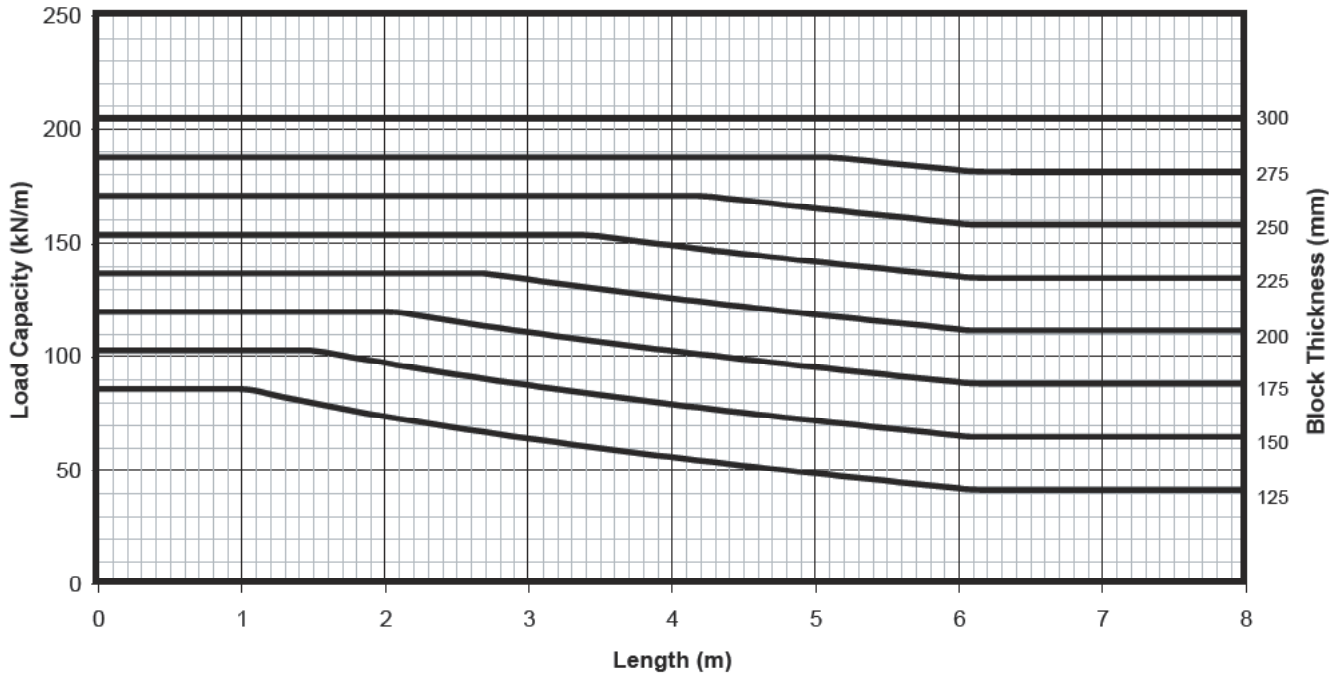
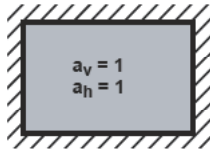

Chart CP10: Thermoblok Walls Up To 3.0m High with One Side Free and Loaded by a Hebel Floor

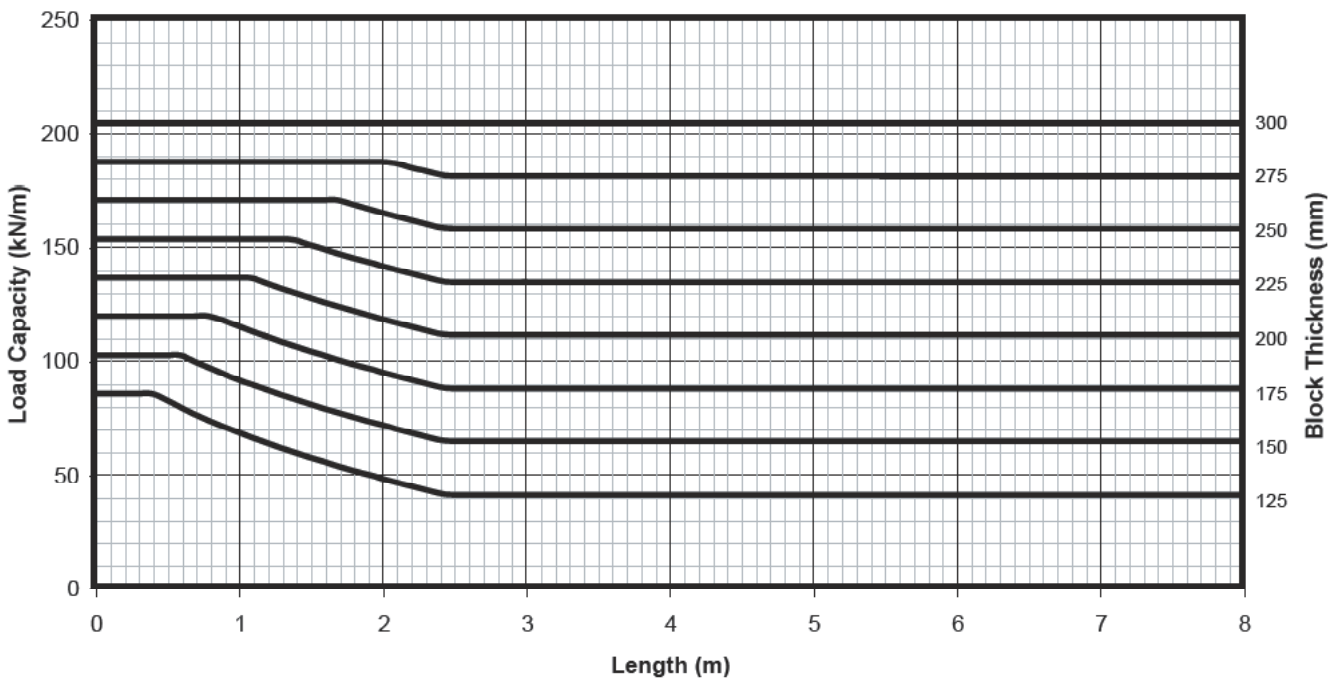
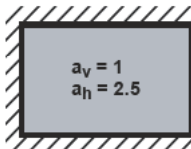

Chart CP11: Sonoblok Walls Up To 3.0m High with Four Edges Laterally Supported and Loaded by a Hebel Floor

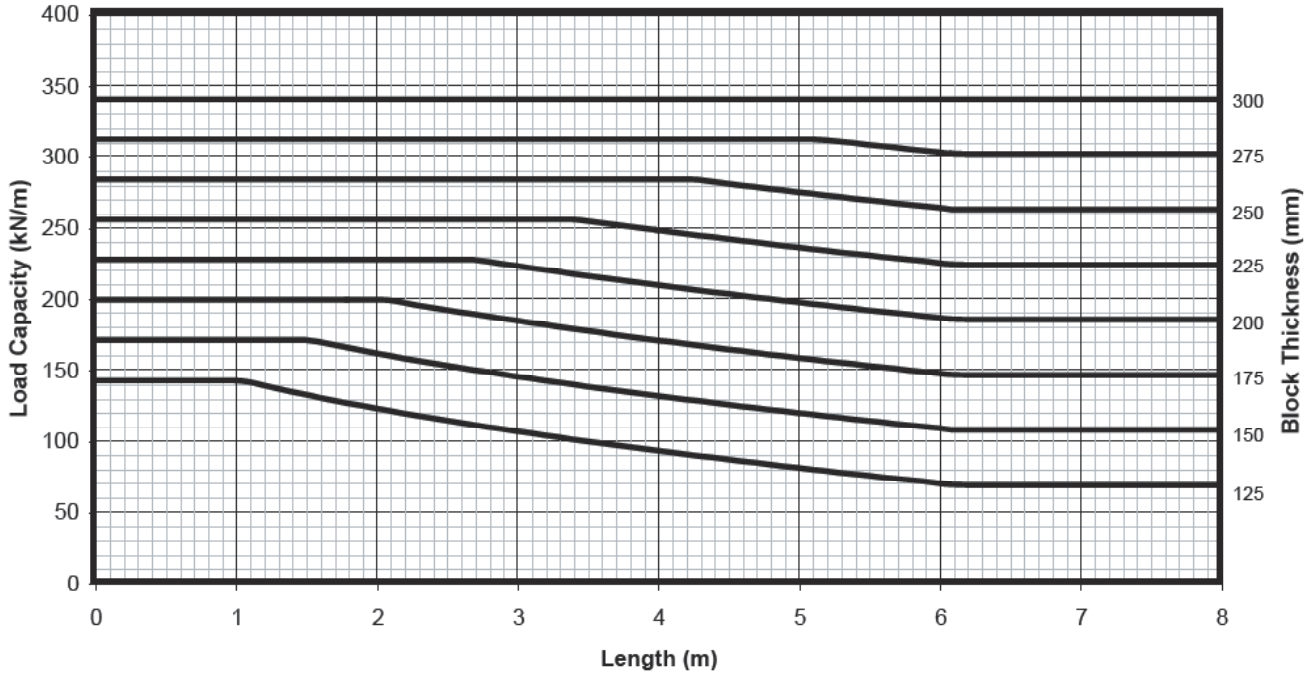
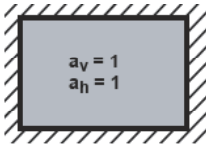
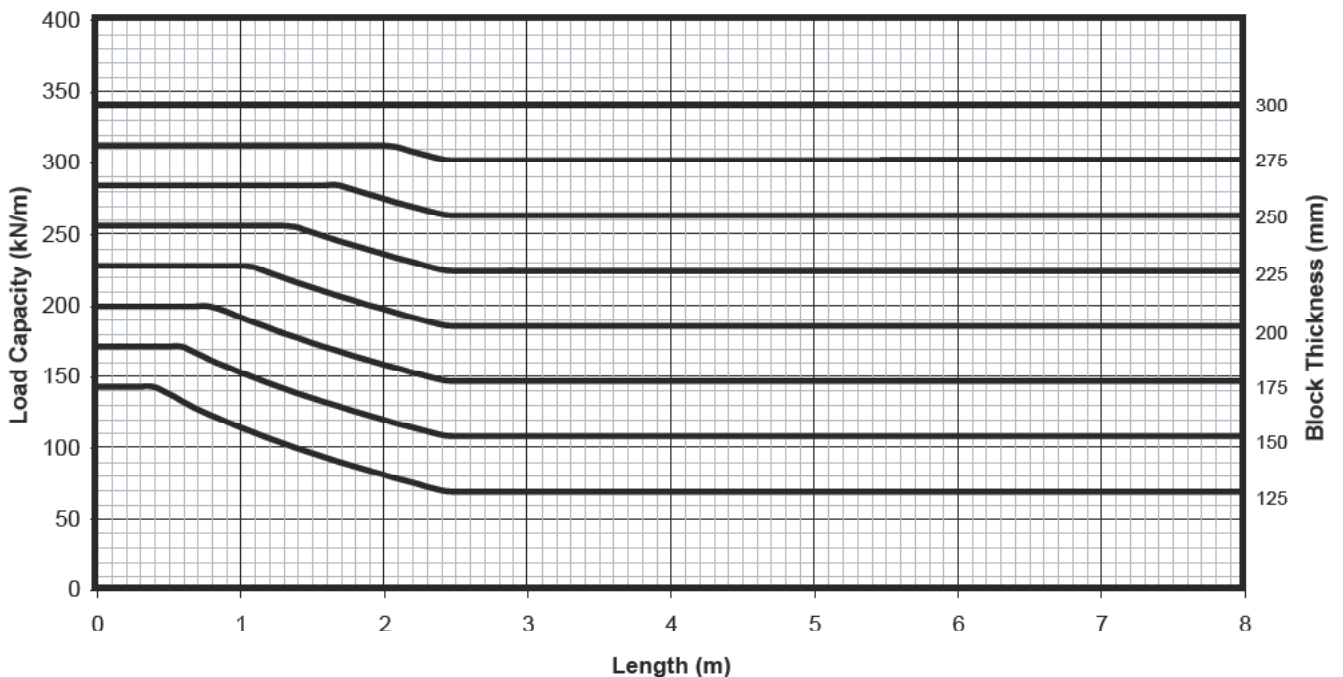
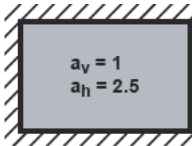

Chart CP12: Sonoblok Walls Up To 3.0m High with One Side Free and Loaded by a Hebel Floor



Section 6

Chart CP13: Thermoblok Walls Up To 2.4m High with Four Edges Laterally Supported and Loaded by a Concrete Slab

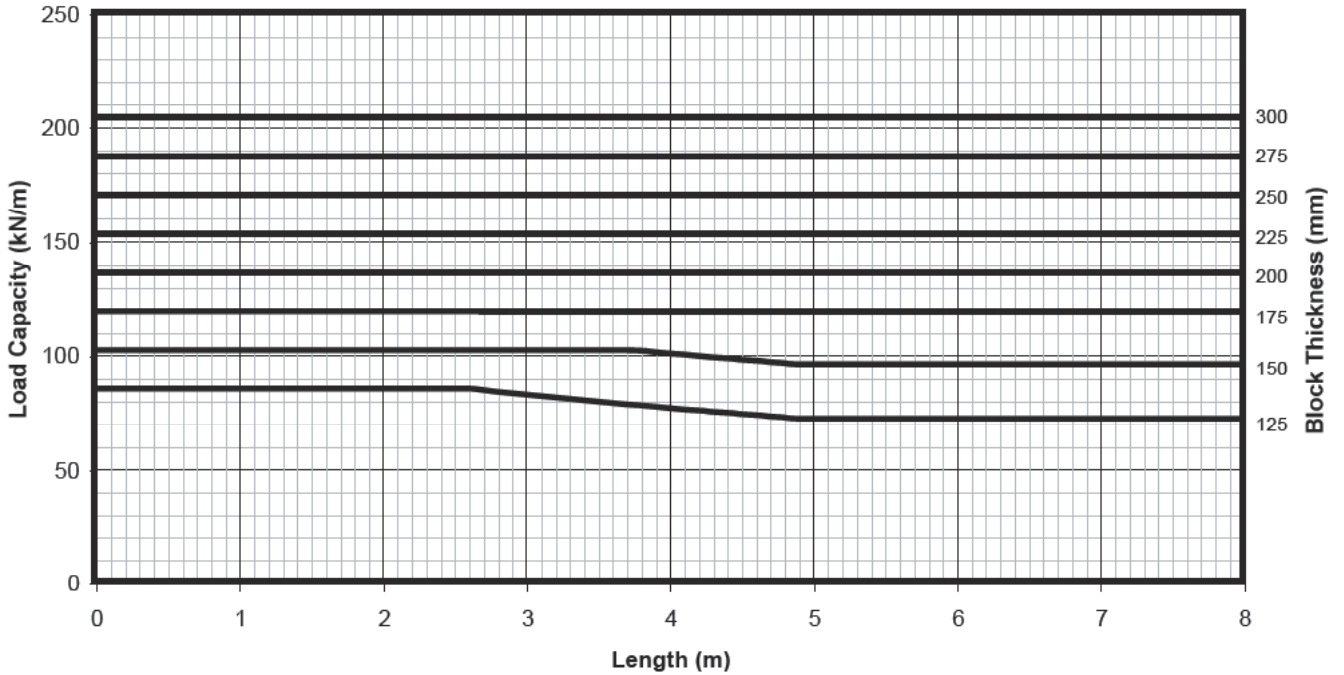
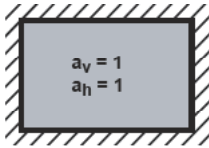

Chart CP14: Thermoblok Walls Up To 2.4m High with One Side Free and Loaded By a Concrete Slab

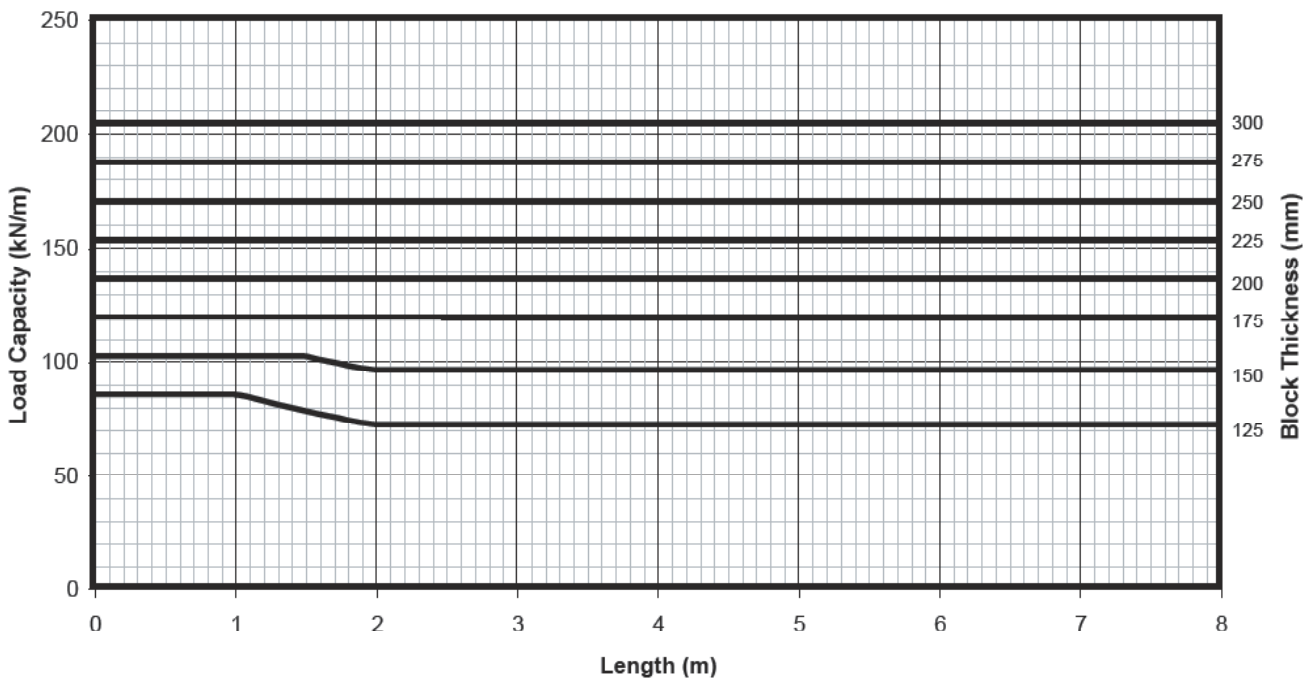
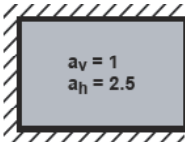

Chart CP15: Sonoblok Walls Up To 2.4m High with Four Edges Laterally Supported and Loaded by a Concrete Slab

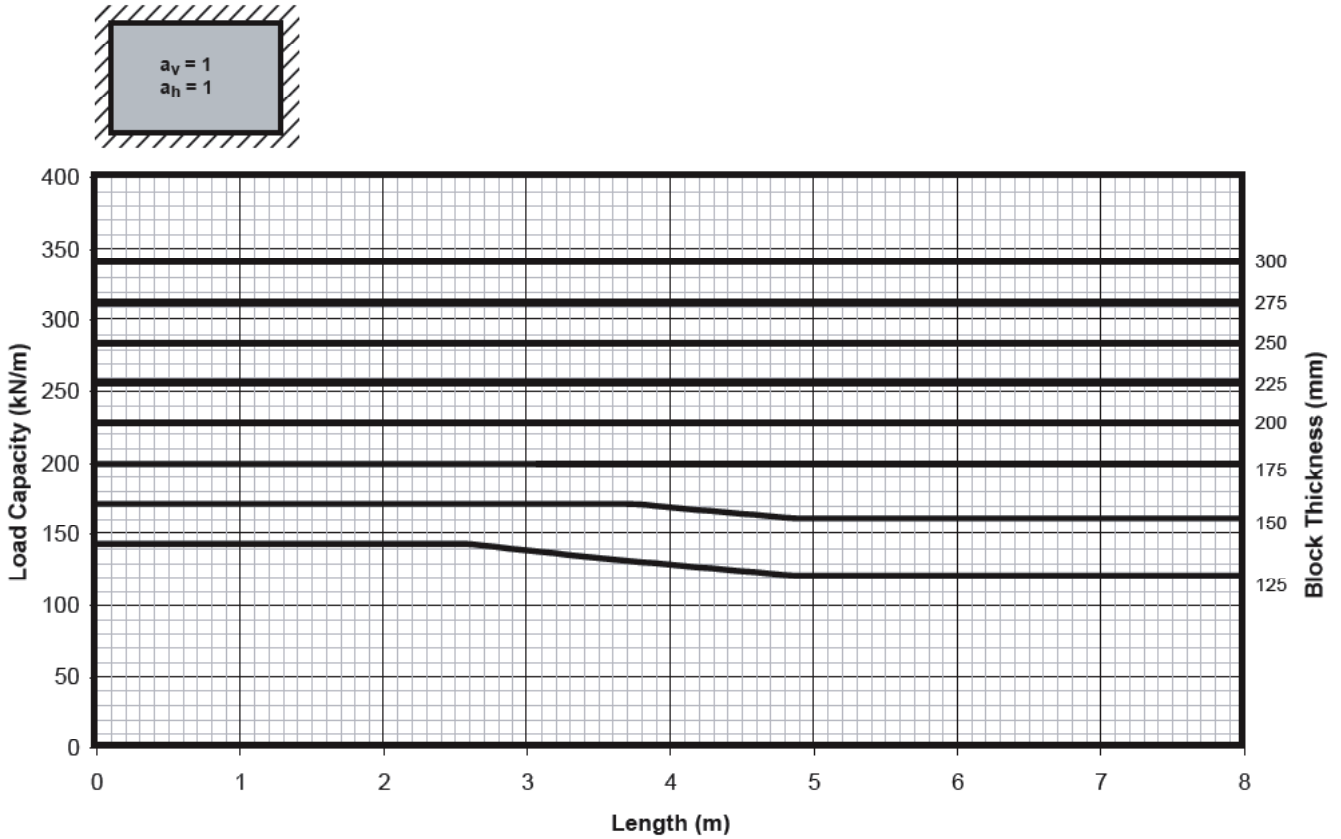

Chart CP16: Sonoblok Walls Up To 2.4m High with One Side Free and Loaded by a Concrete Slab

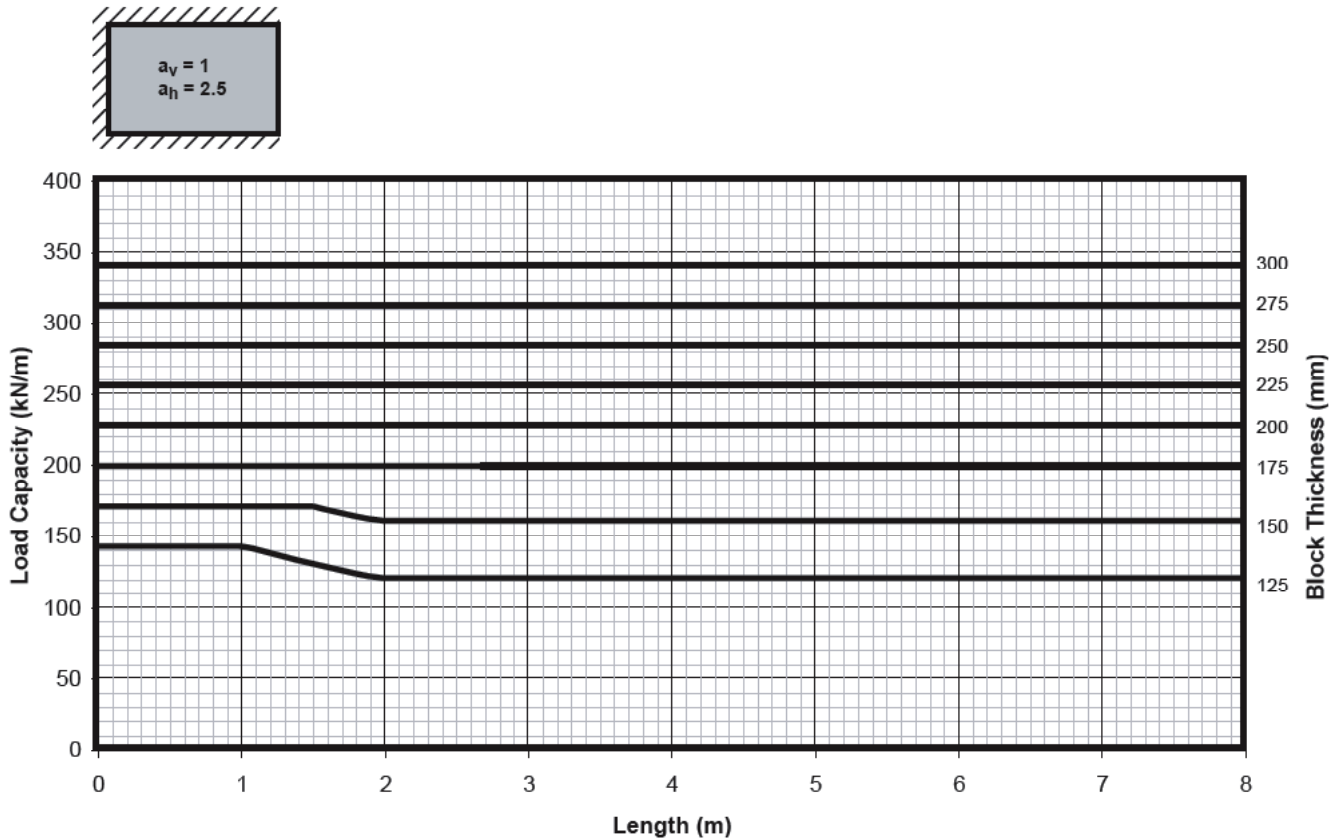

Chart CP17: Thermoblok Walls Up To 2.7m High with Four Edges Laterally Supported and Loaded by a Concrete Slab

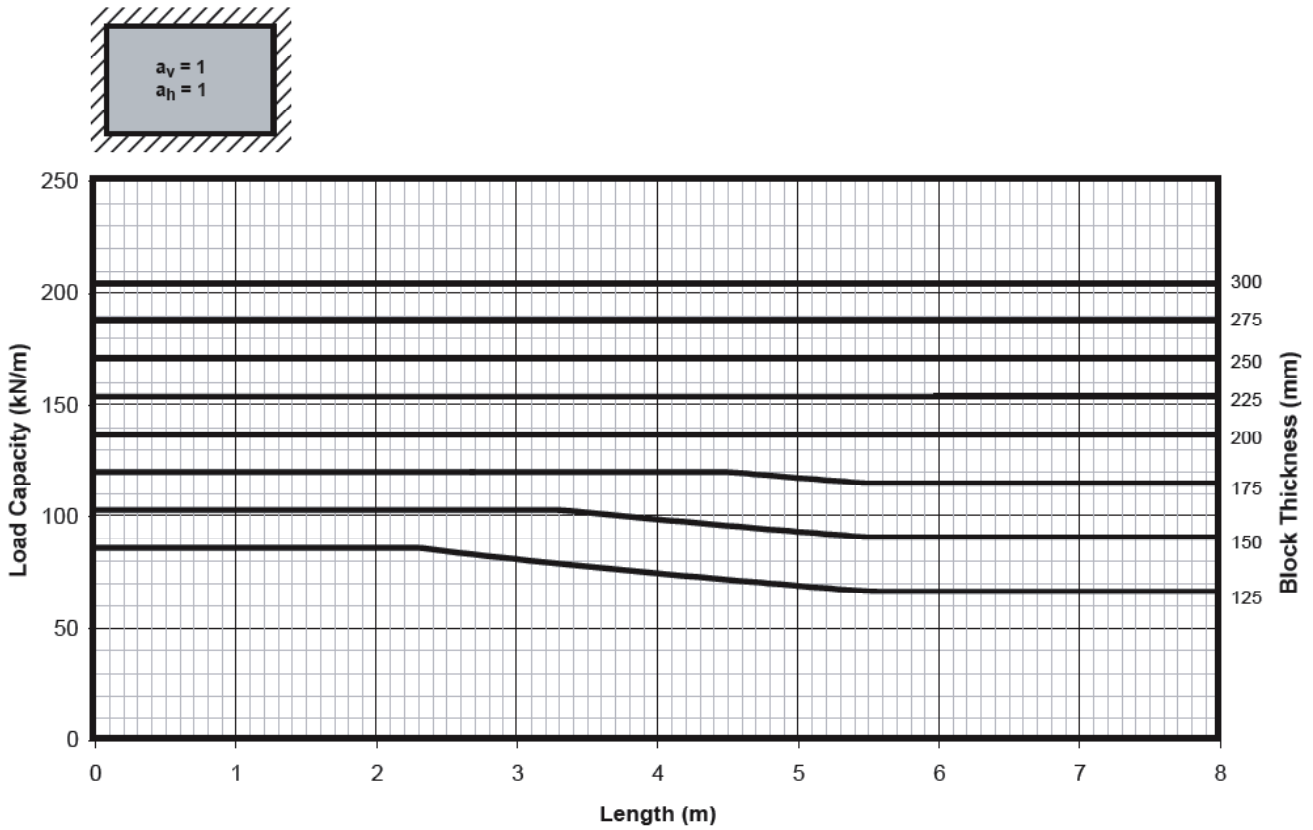

Chart CP18: Sonoblok Walls Up To 2.7m High with One Side Free and Loaded by a Concrete Slab

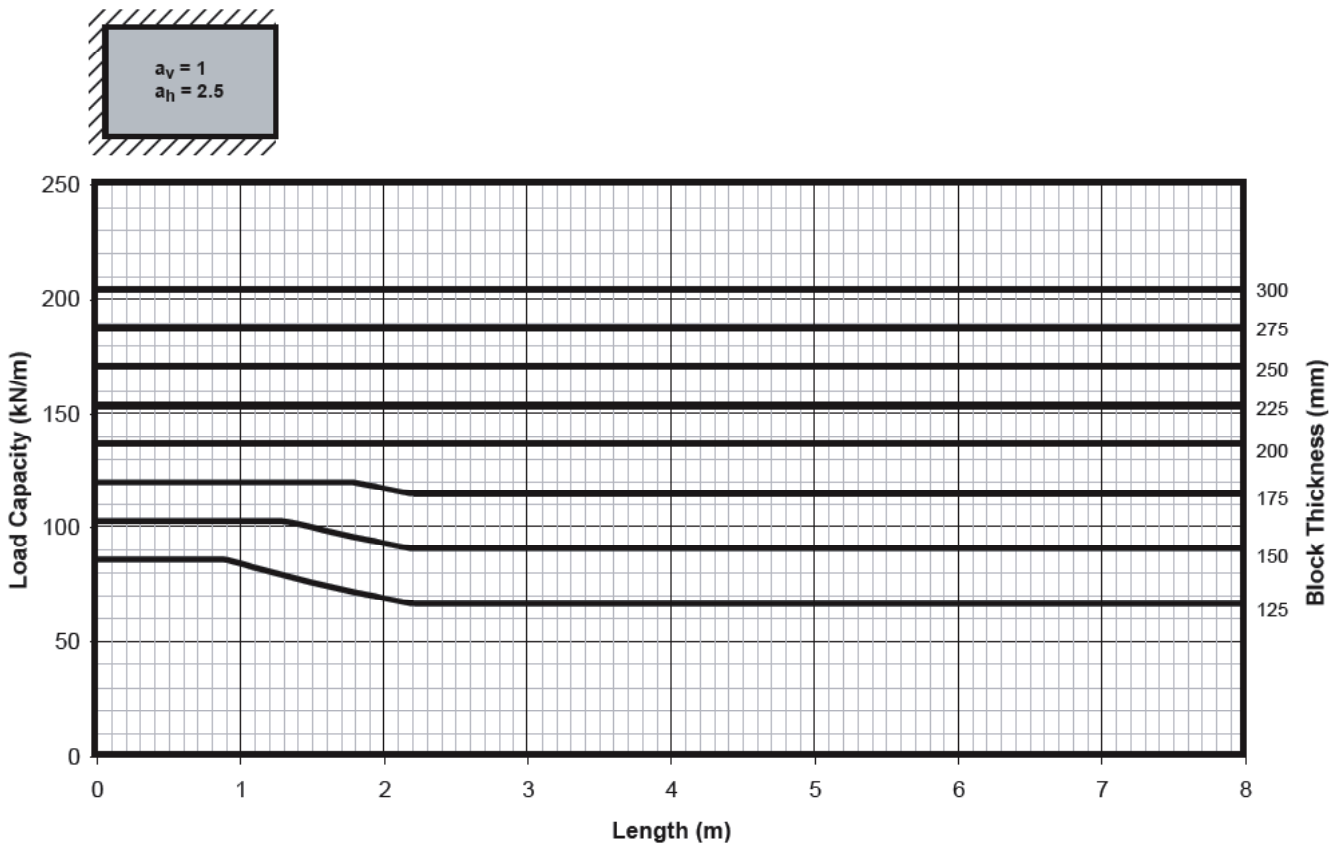

Chart CP19: Sonoblok Walls Up To 2.7m High with Four Edges Laterally Supported and Loaded by a Concrete Slab

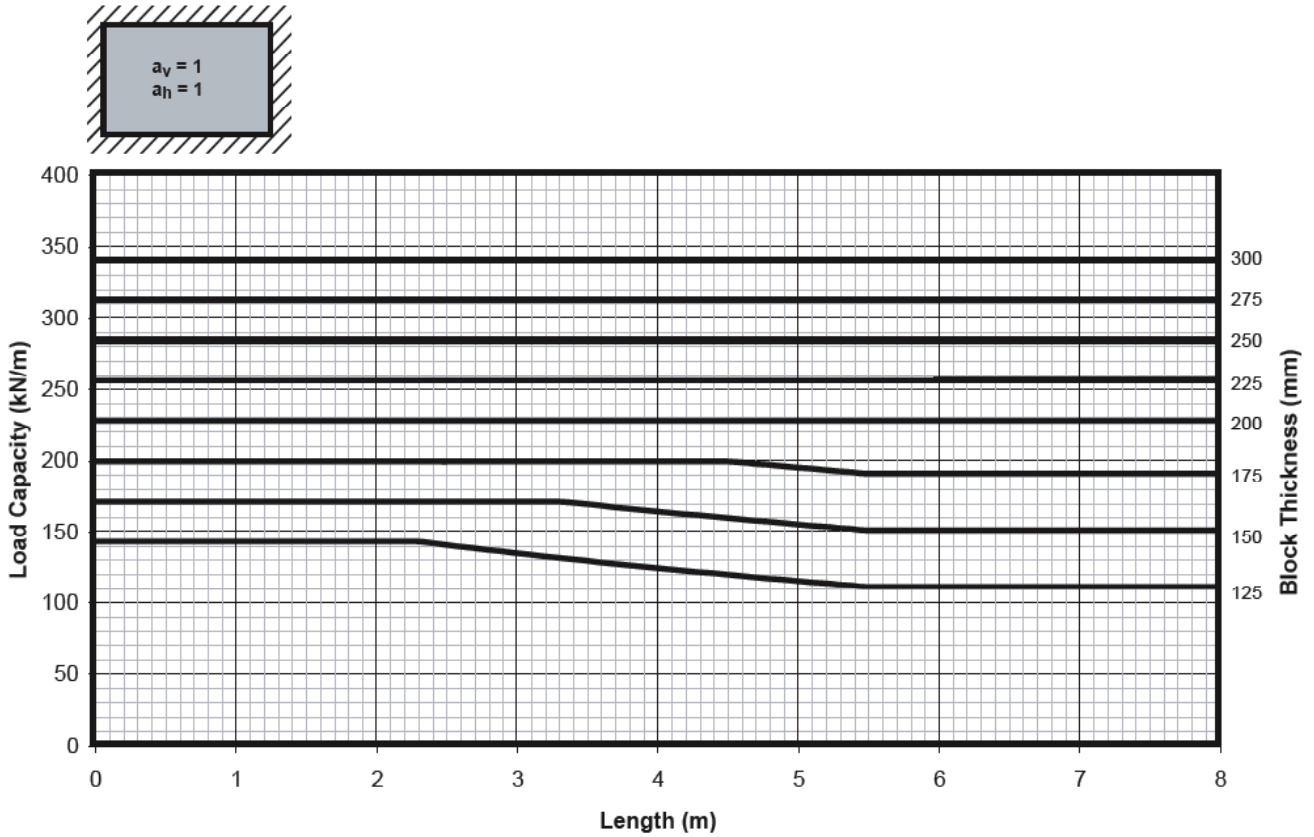

Chart CP20: Sonoblok Walls Up To 2.7m High with One Side Free and Loaded By a Concrete Slab

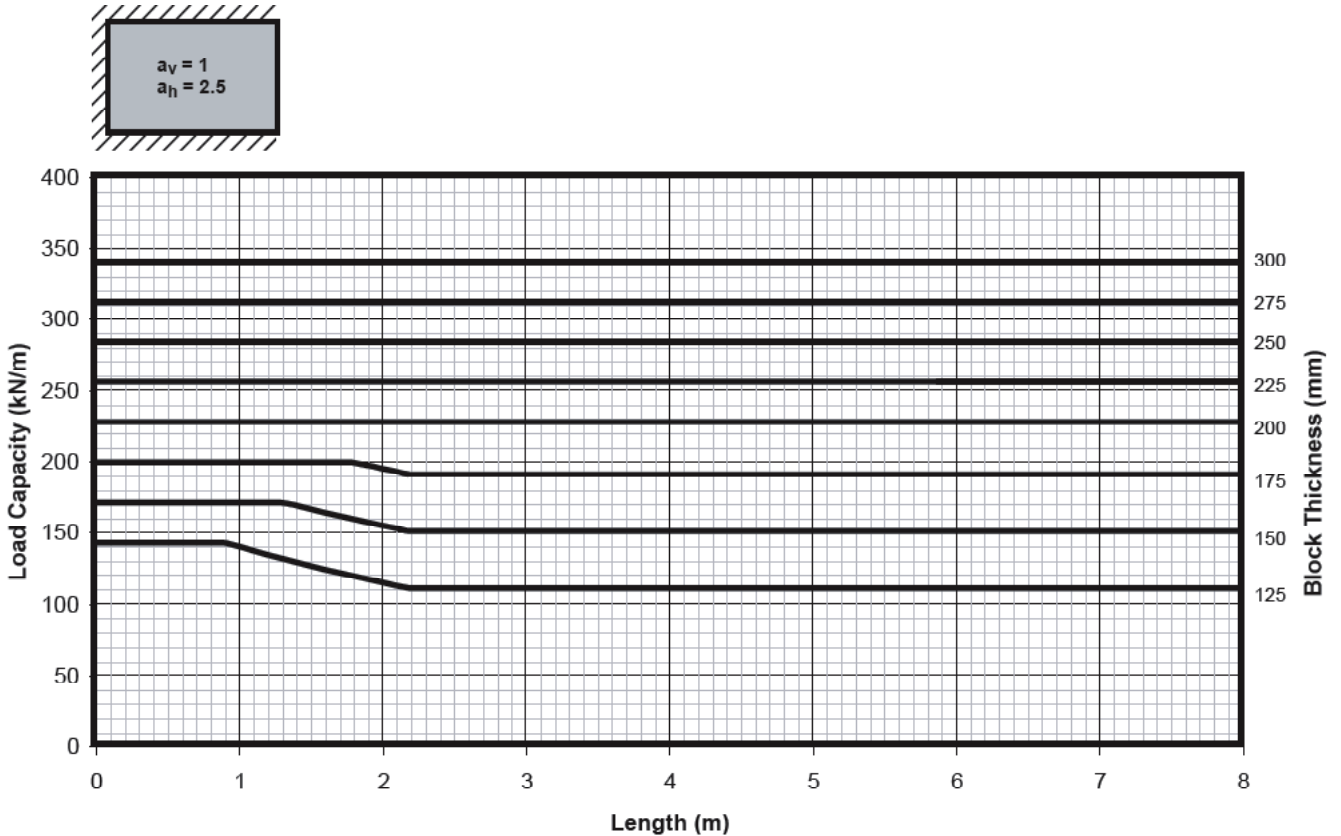

Chart CP21: Thermoblok Walls Up To 3.0m High with Four Edges Laterally Supported and Loaded by a Concrete Slab

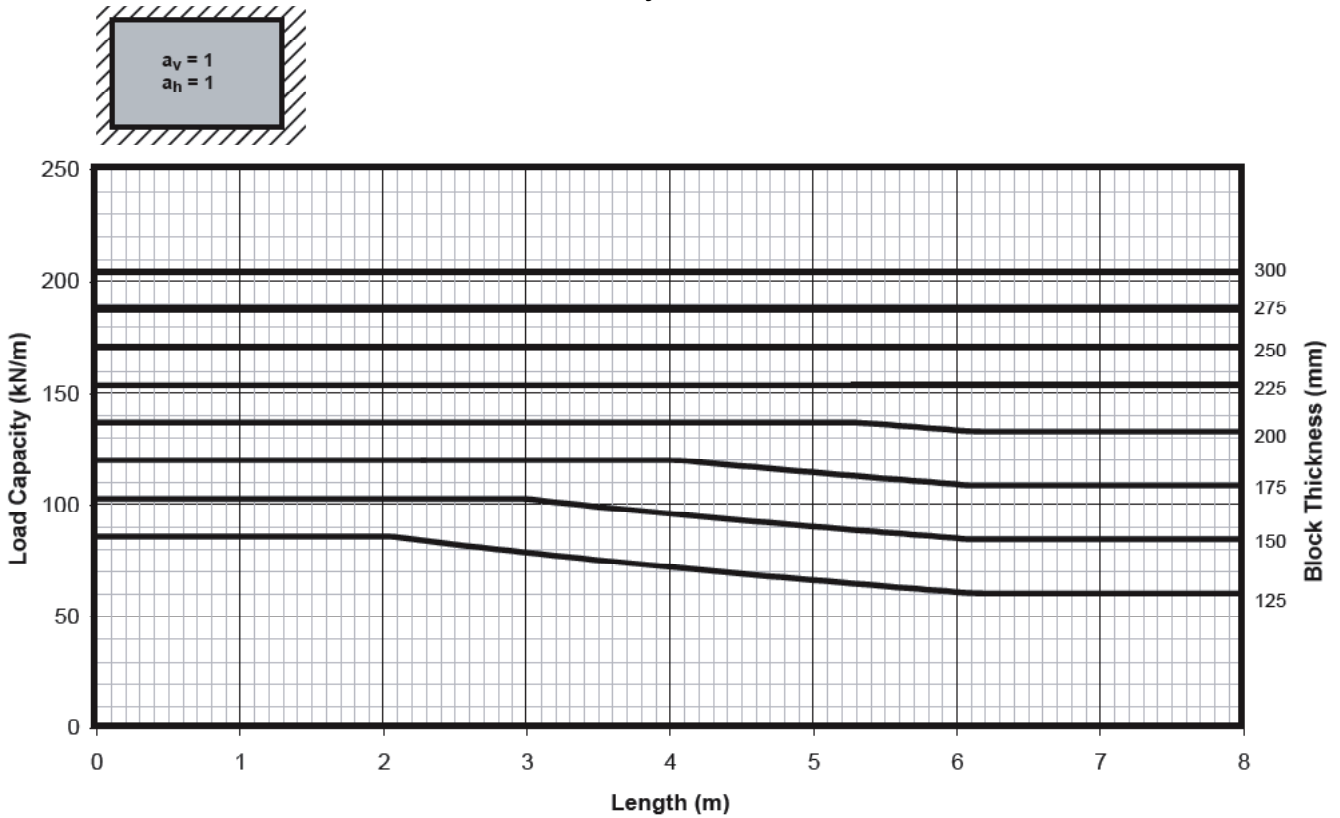

Chart CP22: Thermoblok Walls Up To 3.0m High with One Side Free and Loaded by a Concrete Slab

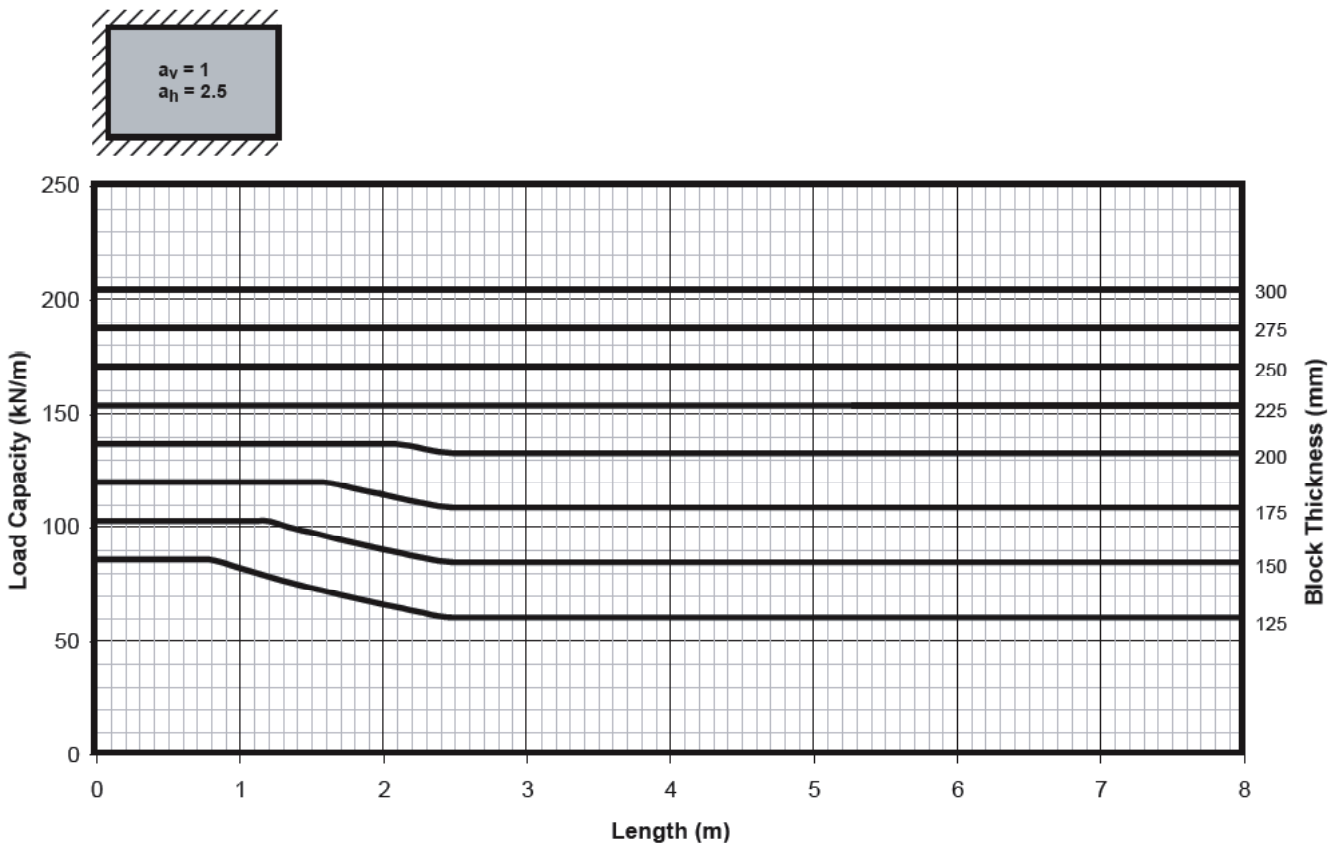

Chart CP23: Sonoblok Walls Up To 3.0m High with Four Edges Laterally Supported and Loaded by a Concrete Slab

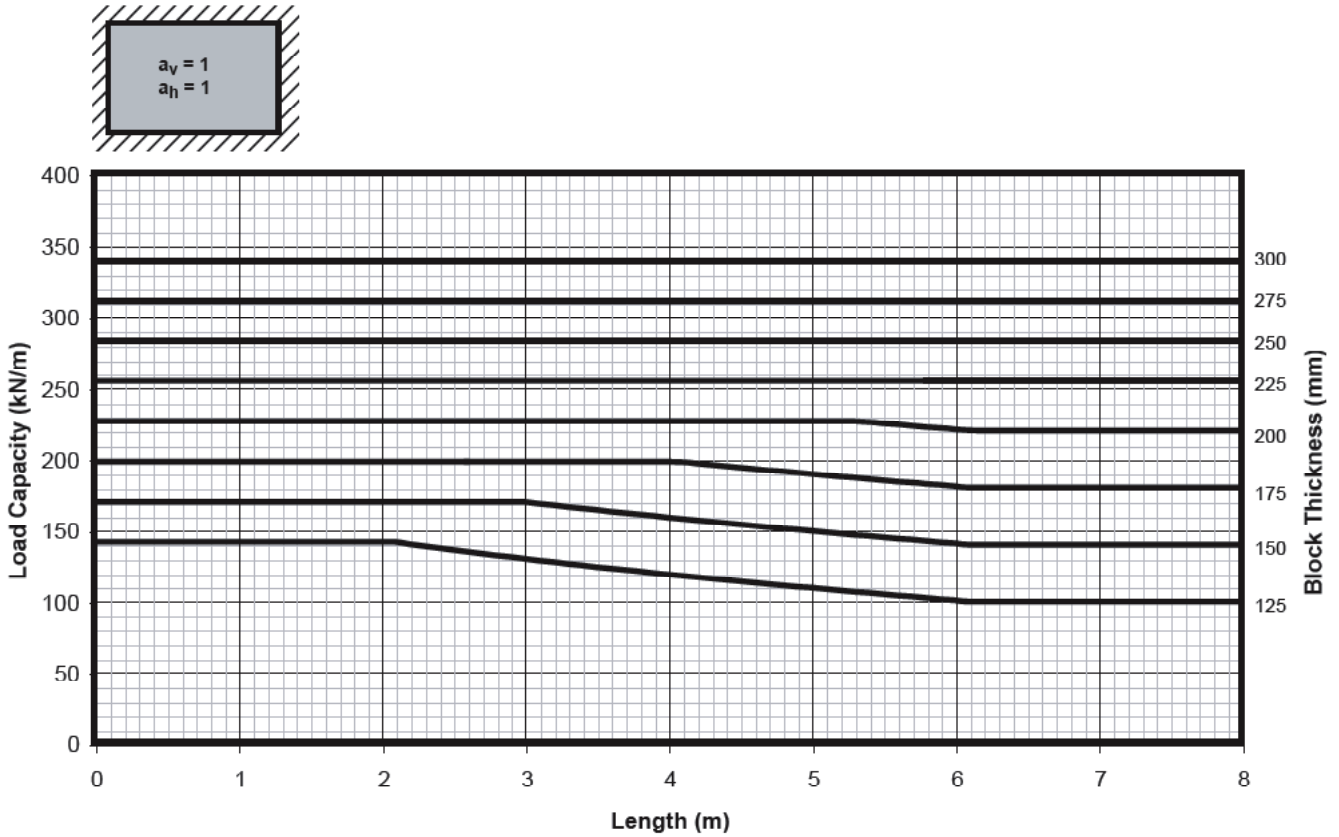
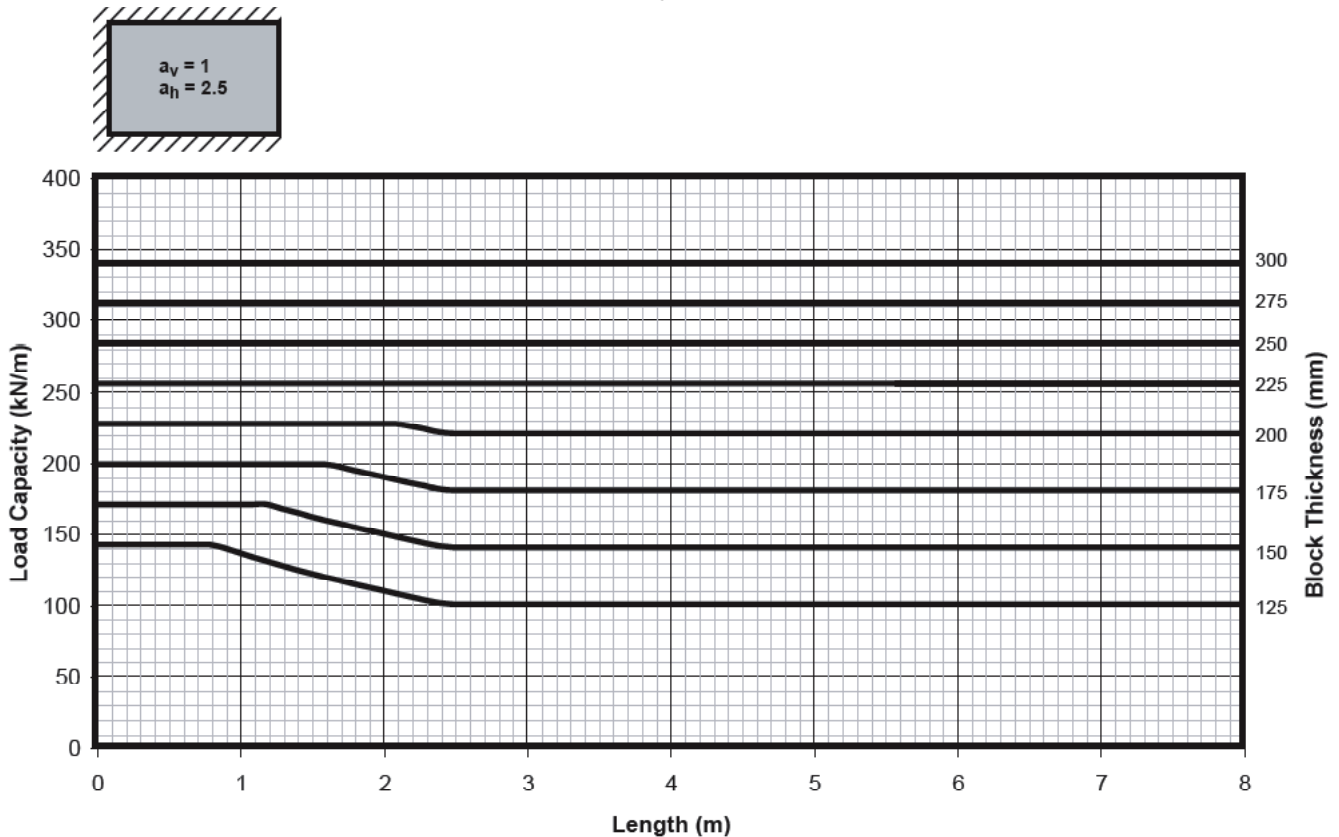

Chart CP24: Sonoblok Walls Up To 3.0m High with One Side Free and Loaded by a Concrete Slab



6.10 Design for Bending

The load capacity of a wall in bending depends upon the cross-sectional properties, characteristic flexural tensile strength, characteristic lateral modulus of rupture of the material, and the support conditions at the edges of the wall. Edges can either be free, simply supported, or rotationally restrained. In practice, it is difficult to achieve rotational restraint at the top or bottom edge of a wall. While AS3700 provides for rotational restraint at the vertical edges, this has not been considered in the design charts presented here.

AAC walls can be designed for bending using the rules in AS3700 Clause 7.4, where vertical bending is covered by Clause 7.4.2, horizontal bending by Clause 7.4.3 and two-way bending by Clause 7.4.4.

Both Clause 7.4.3 and Clause 7.4.4 provide rules specifically for AAC masonry with thin-bed joints because its behaviour differs from that of masonry laid in conventional mortar joints.

The vertical bending expressions in Clause 7.4.2 have been used to derive Chart BD1, using a characteristic flexural tensile strength (f_{mt}) of 0.2 MPa and the factor k_{mt} equal to 1.3 as specified in AS3700 for AAC masonry. Vertical loading enhances the vertical bending strength and the self-weight of Thermoblok has been considered for this purpose in the derivation of the chart. Negligible further enhancement would result from the use of Sonoblok and the same chart therefore applies to both masonry unit types.

The horizontal bending expression in Clause 7.4.3.2(b) has been used to derive Chart BD2 for Thermoblok walls and Chart BD3 for Sonoblok walls of various thicknesses. Characteristic lateral modulus of rupture values appropriate to the two masonry unit types have been used (see Table 2.3 of this publication).

For walls in two-way bending, AS3700 caters for various support conditions by the use of coefficients b_v and b_h as shown in Table 6.5. These coefficients and the expressions for bending in AS3700 Clause 7.4.4.3 have been used to generate design charts for Thermoblok and Sonoblok walls with heights of 2.4, 2.7 and 3.0 metres (see Chart BD4 to Chart BD15). Each chart shows an icon to indicate the lateral support conditions. Separate lines are shown on the charts for block thicknesses from 75mm to 300mm. AS3700 limits the application of these rules for two-way bending to walls without openings and with L/H not exceeding 2.5 (see Clause 7.4.4.3). The curves in Chart BD4 to Chart BD15 therefore terminate at the length corresponding to this limit.

**Table 6.5: Bending Coefficients
(from AS 3700 Table 7.5)**

Support Conditions at the Top and Bottom	b_v
Lateral support on top and bottom	1.0
Lateral support at bottom only	0.25
Support Conditions at the Sides	b_h
Lateral support on both vertical edges	1.0

A capacity reduction factor of 0.6 has been used for all bending charts (see AS3700 Table 4.1). The length and height of the wall are clear dimensions between supports in all cases.

To use the charts, the factored out-of-plane load should be determined in accordance with the relevant Australian standard and compared with the load capacity given by the appropriate chart for the block type, wall height, support configuration and block thickness.

If additional moment capacity is required, the following options can be investigated and should be designed by a practicing structural engineer.

1. Precompression via the holding down bolts; or
2. Grouting in of the bolts.

Chart BD1: Vertical Bending for Thermoblok and Sonoblok Walls

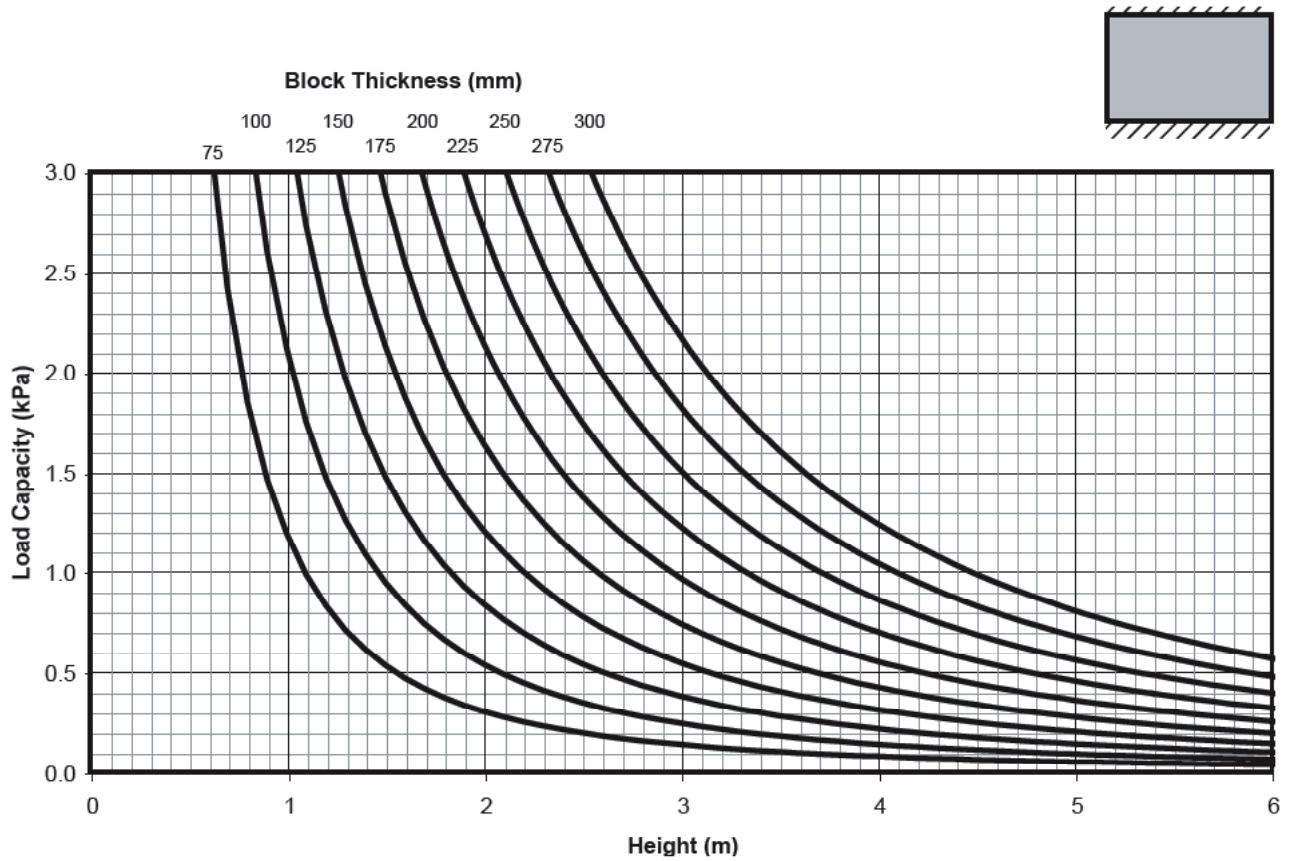

Chart BD2: Horizontal Bending for Thermoblok Walls

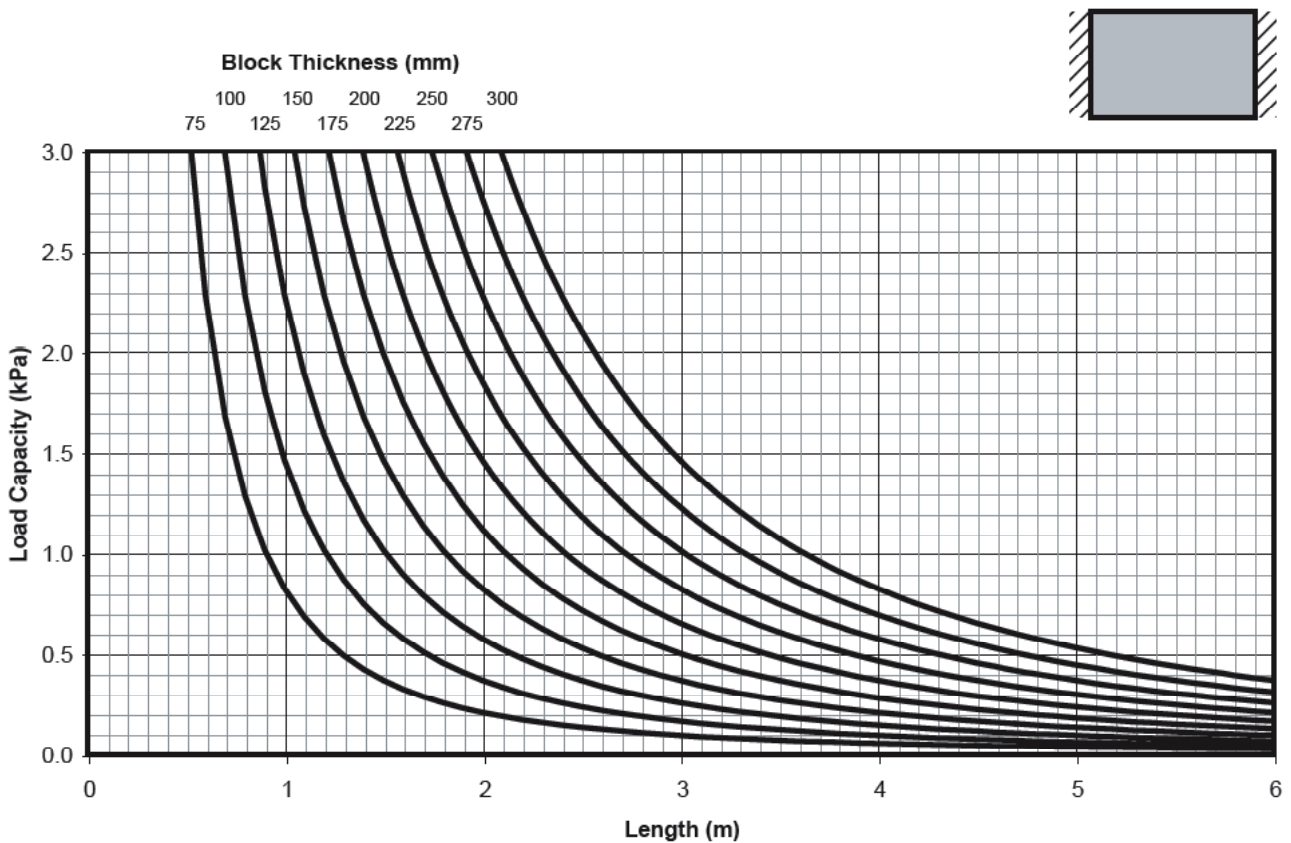
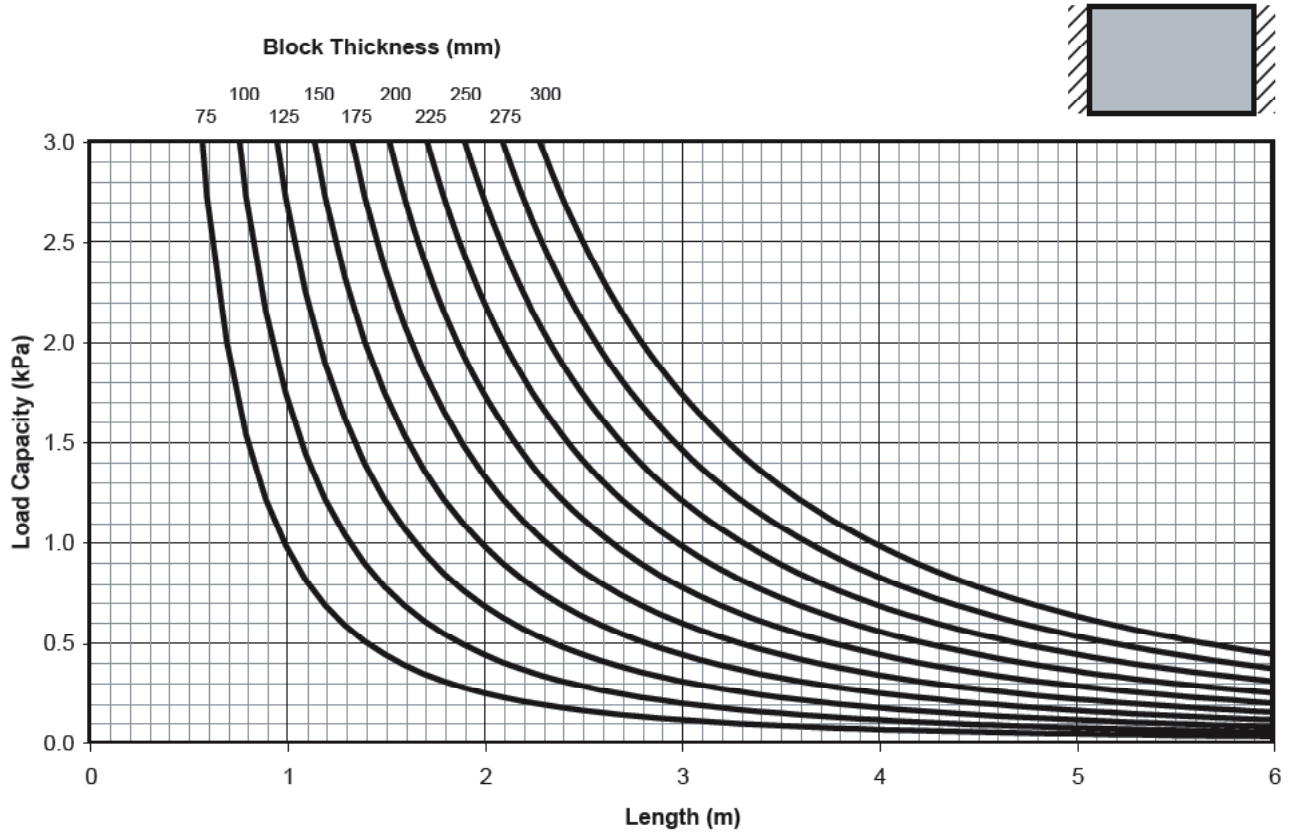
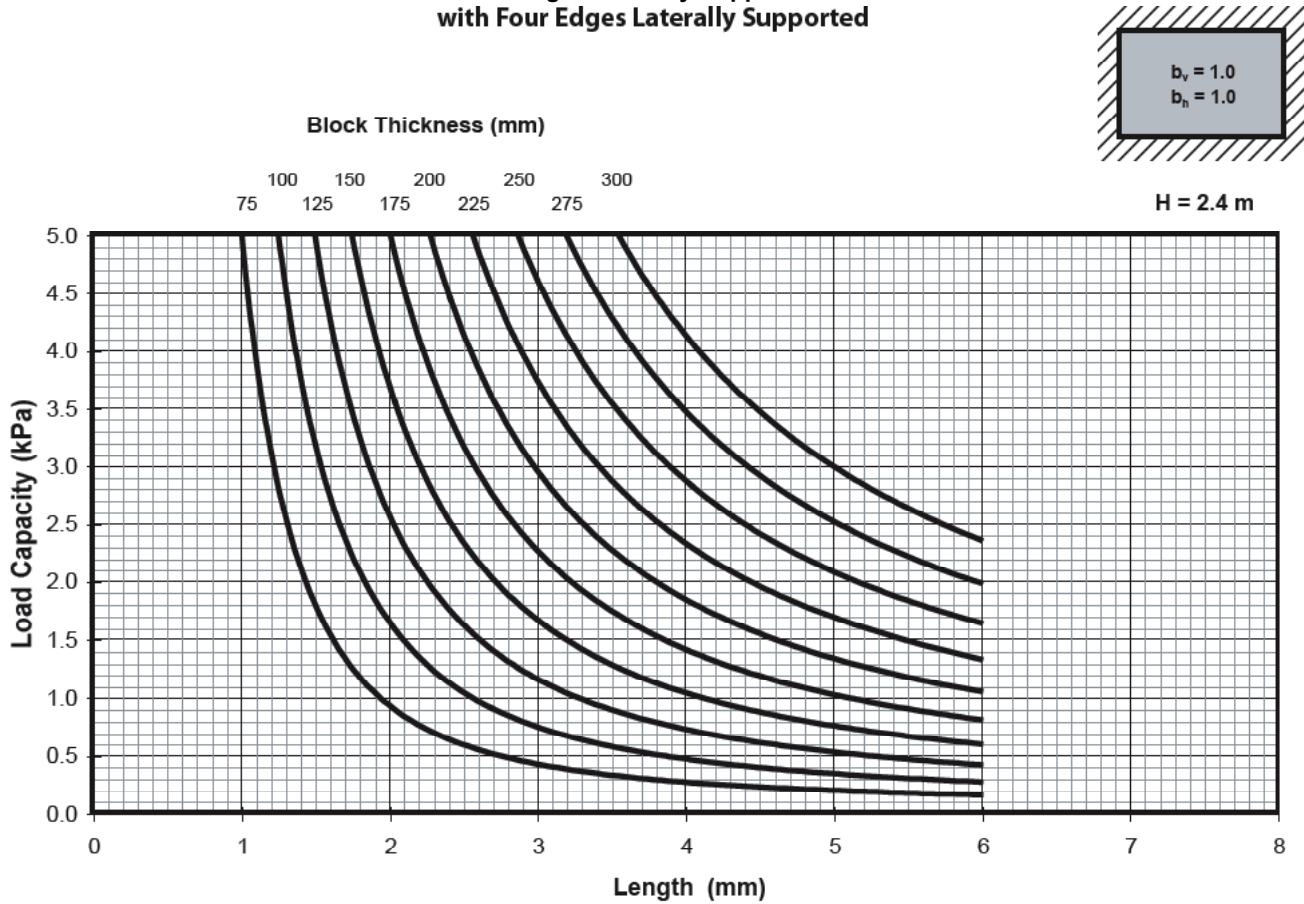

Chart BD3: Horizontal Bending for Sonoblok Walls



**Chart BD4: Two-way Bending for Thermoblok Walls 2.4 m High
with Four Edges Laterally Supported
with Four Edges Laterally Supported**



**Chart BD5: Two-way Bending for Sonoblok Walls 2.4 m High
with Four Edges Laterally Supported**

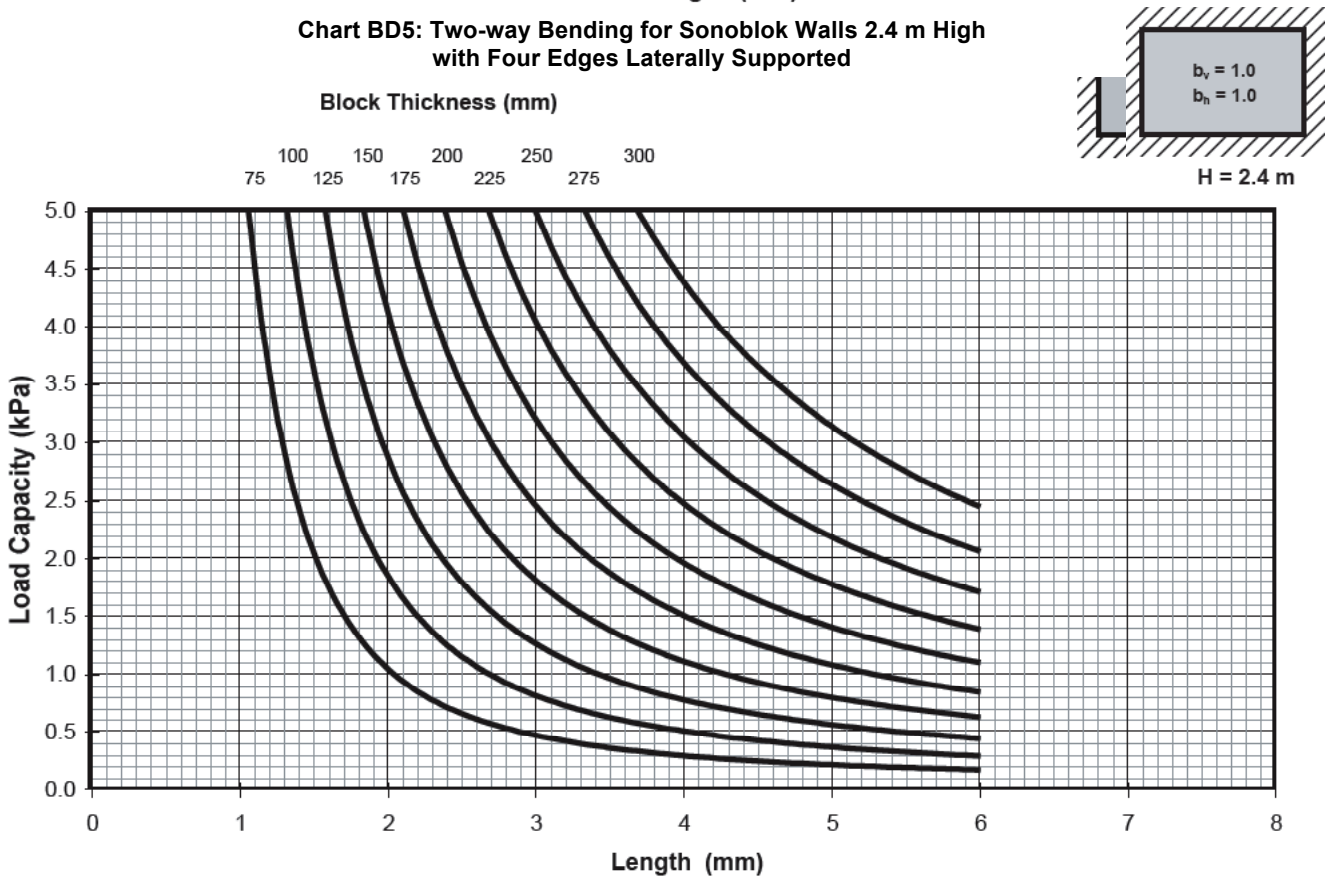

Section 6

Chart BD6: Two-way Bending for Thermoblok Walls 2.7 m High with Four Edges Laterally Supported

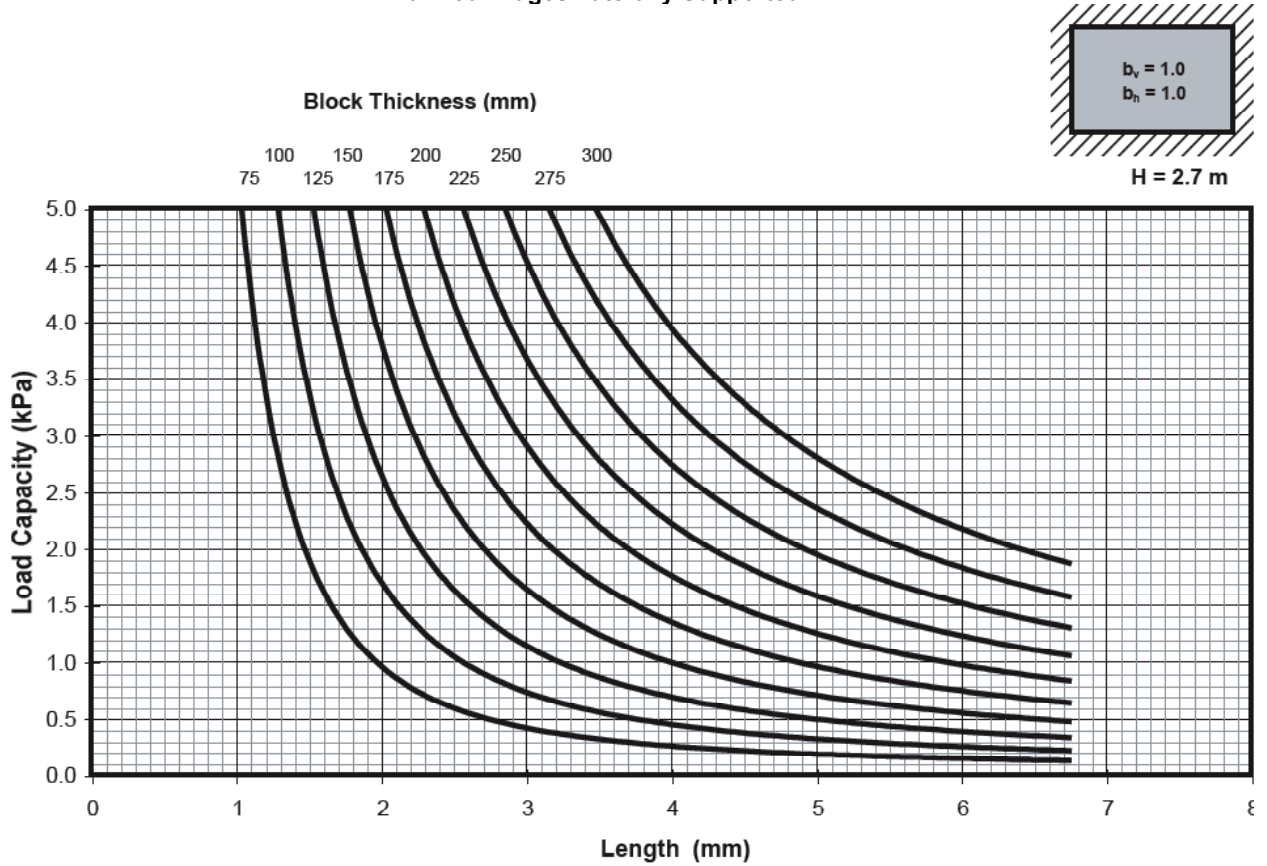
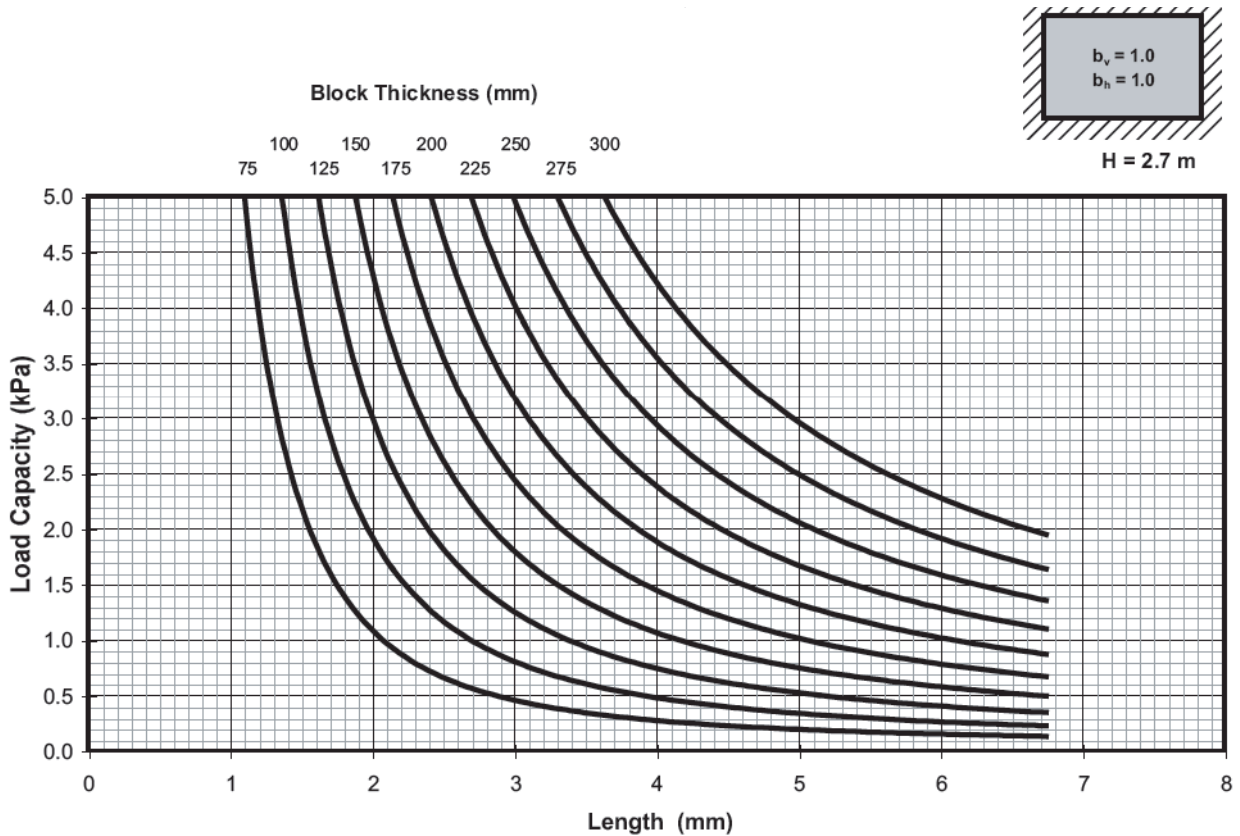

Chart BD7: Two-way Bending for Sonoblok Walls 2.7 m High with Four Edges Laterally Supported



Section 6

Chart BD8: Two-way Bending for Thermoblok Walls 3.0 m High with Four Edges Laterally Supported

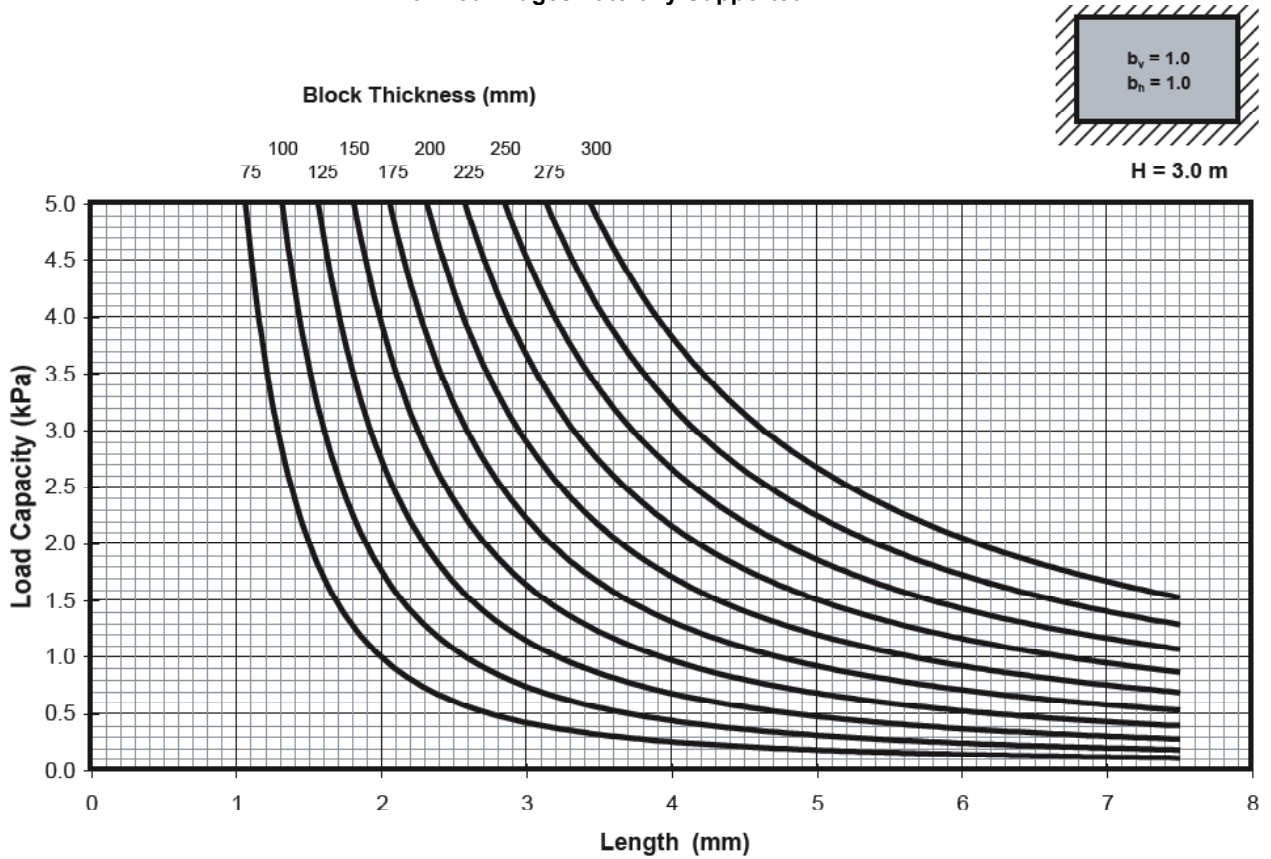
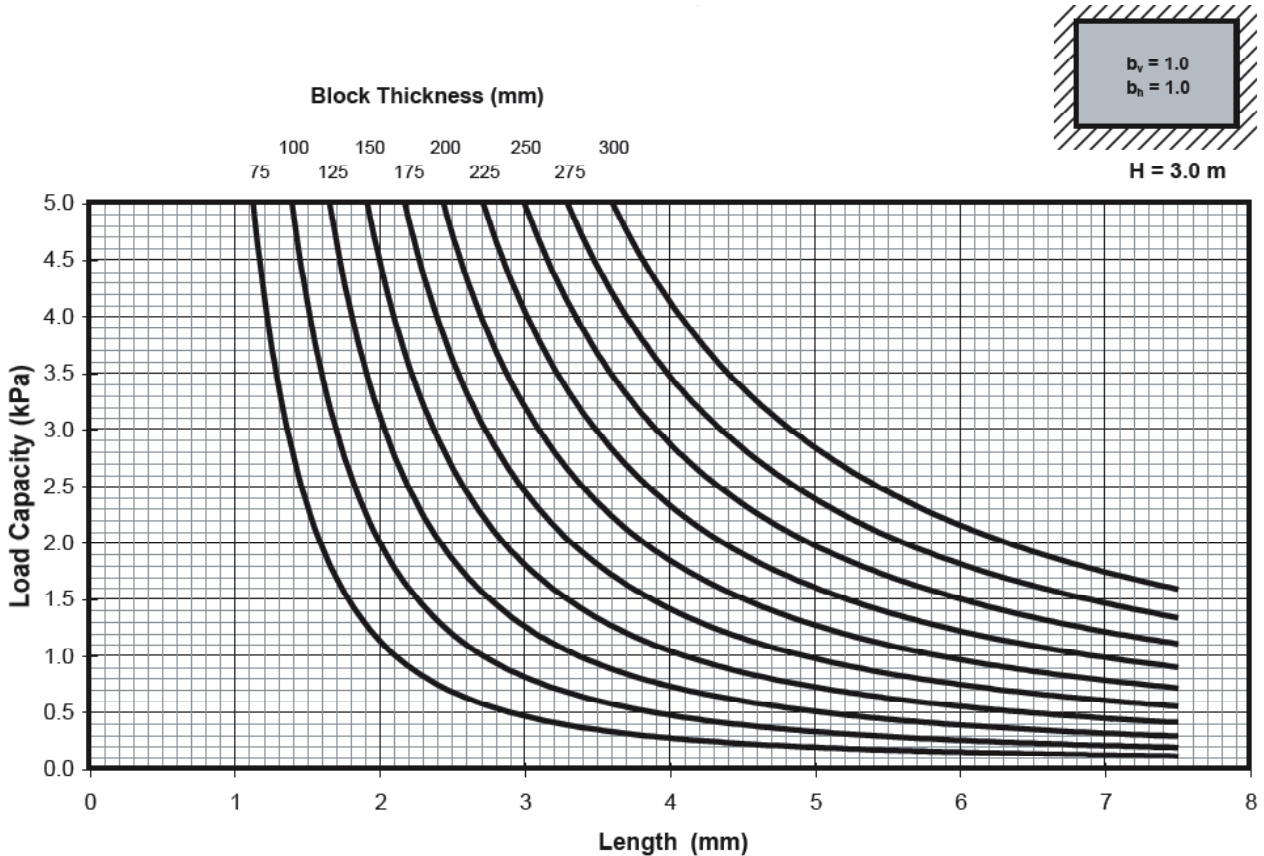

Chart BD9: Two-way Bending for Sonoblok Walls 3.0 m High with Four Edges Laterally Supported



Section 6

Chart BD10: Two-way Bending for Thermoblok Walls 2.4m High with the Top Free

Block Thickness (mm)

100 150 200 250 300
75 125 175 225 275

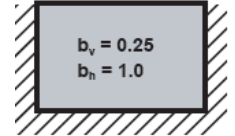

H = 2.4 m

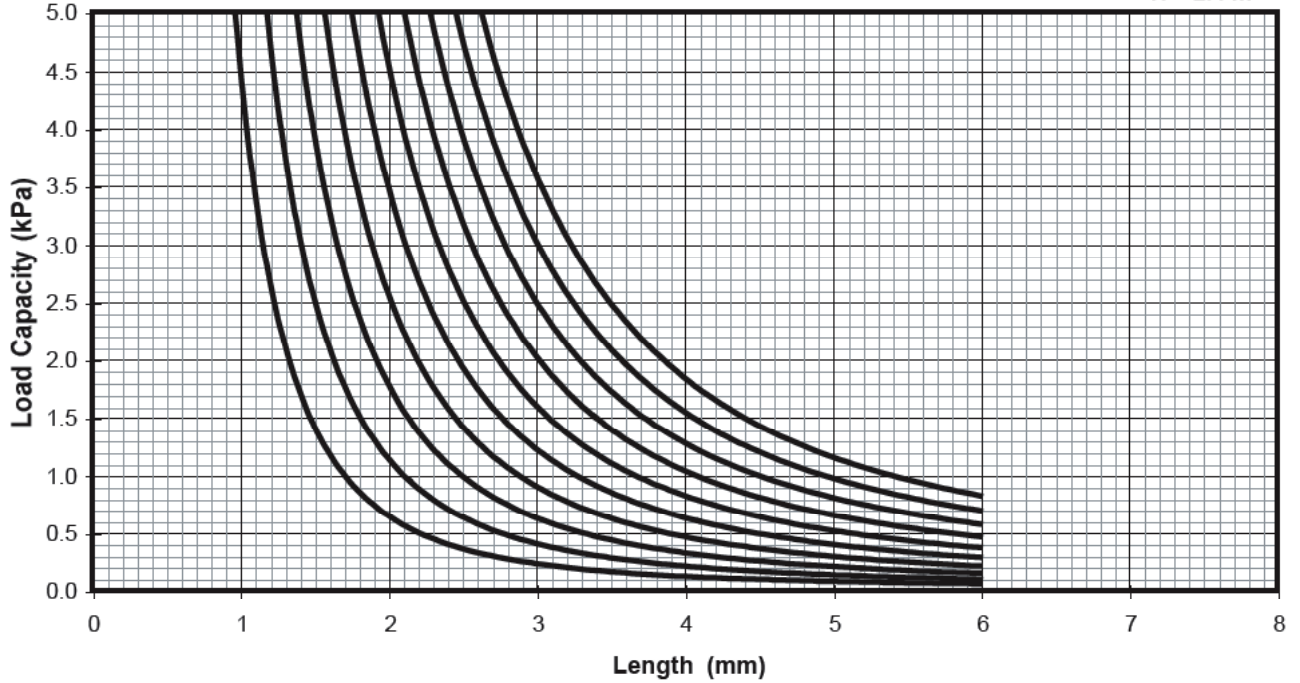
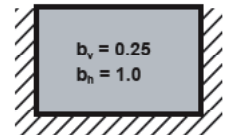

Chart BD11: Two-way Bending for Sonoblok Walls 2.4 m High with the Top Free

Block Thickness (mm)

100 150 200 250 300
75 125 175 225 275



H = 2.4 m

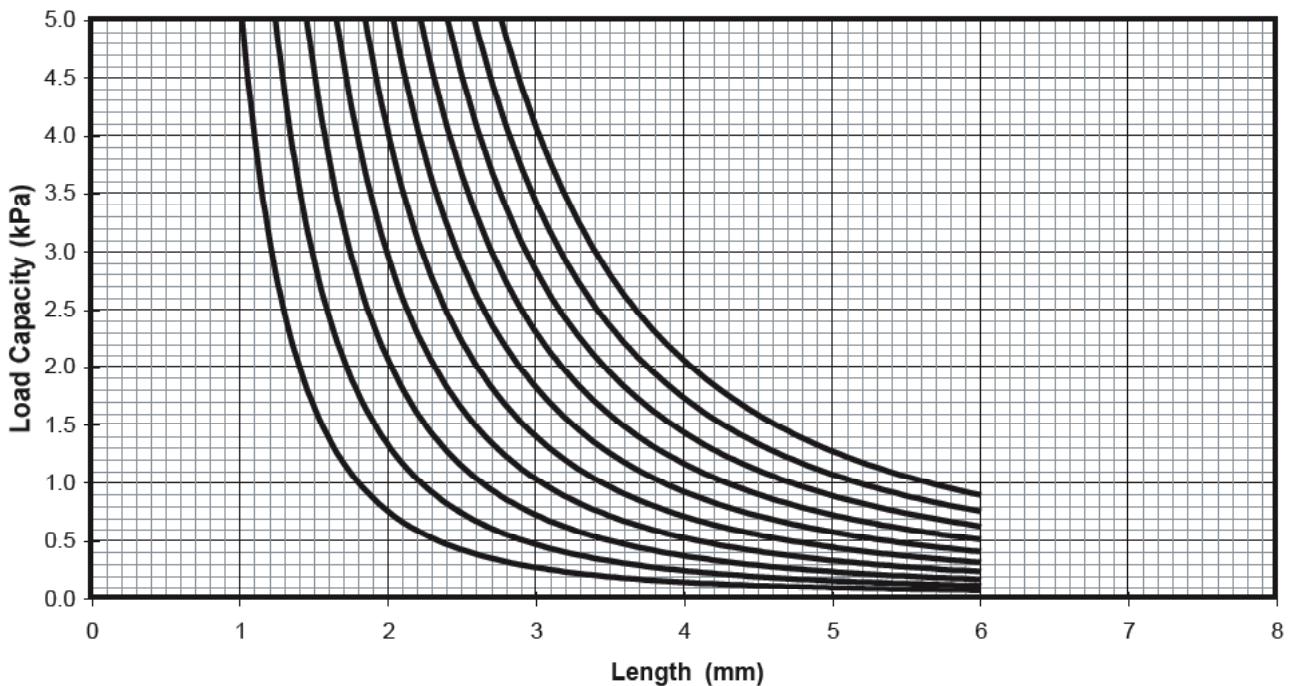

Chart BD12: Two-way Bending for Thermoblok Walls 2.7 m High with the Top Free

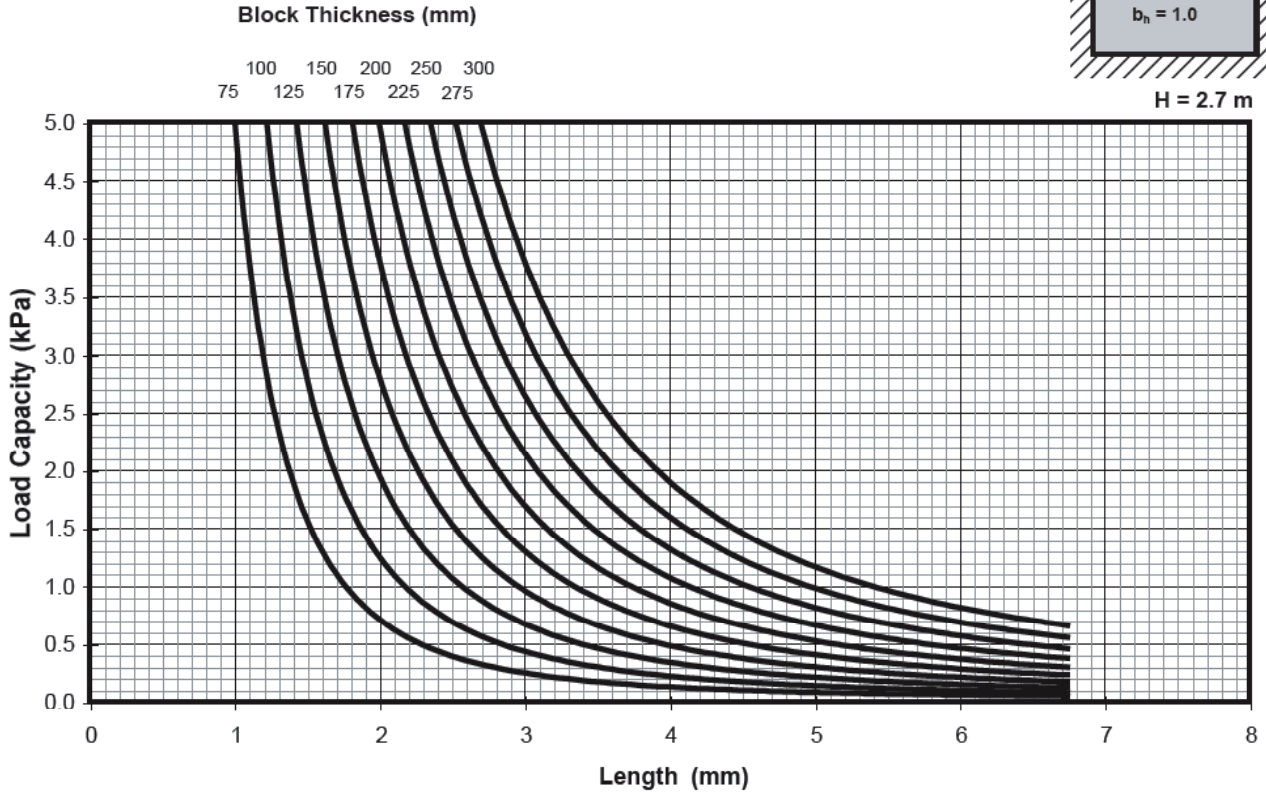

Chart BD13: Two-way Bending for Sonoblok Walls 2.7 m High with the Top Free

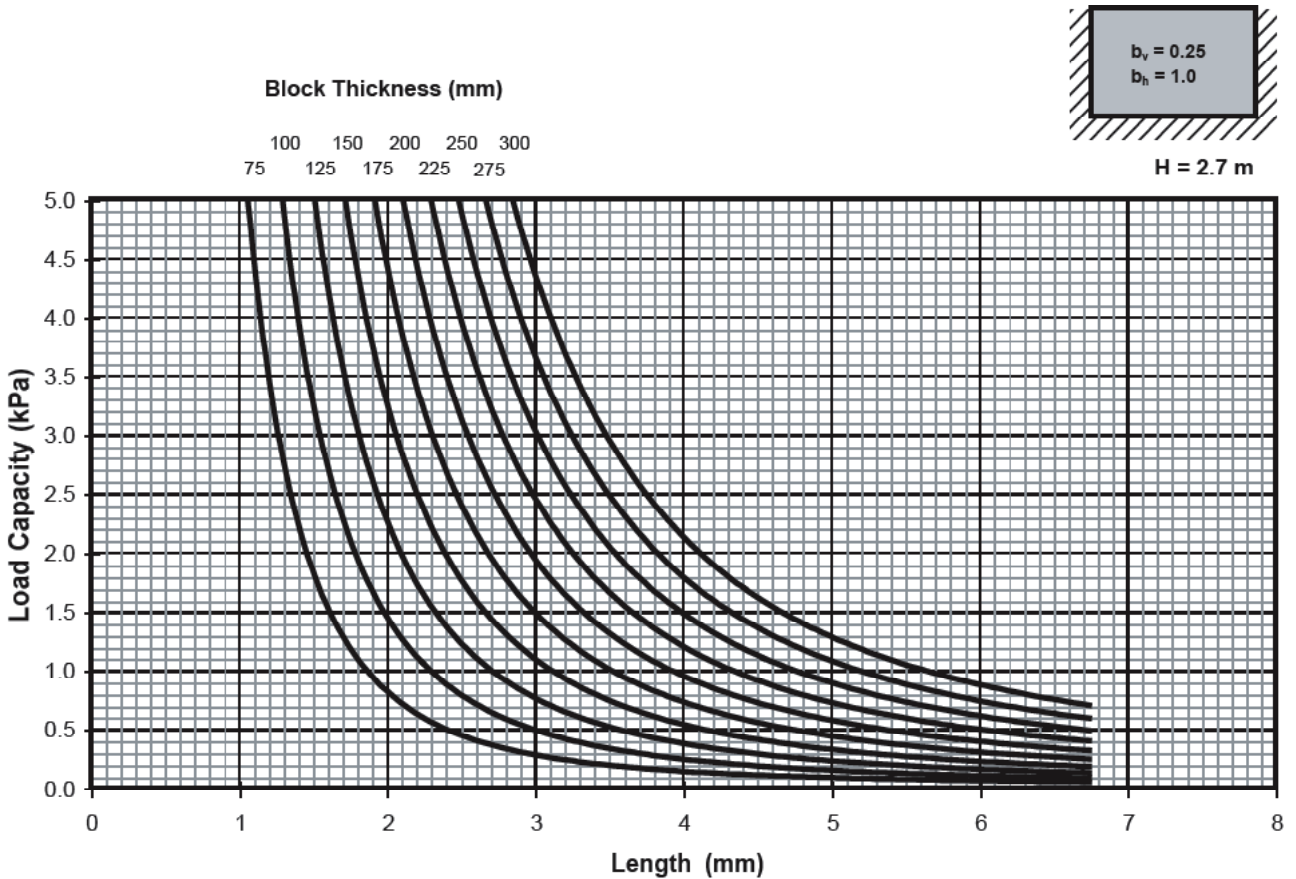

Chart BD14: Two-way Bending for Thermoblok Walls 3.0 m High with the Top Free

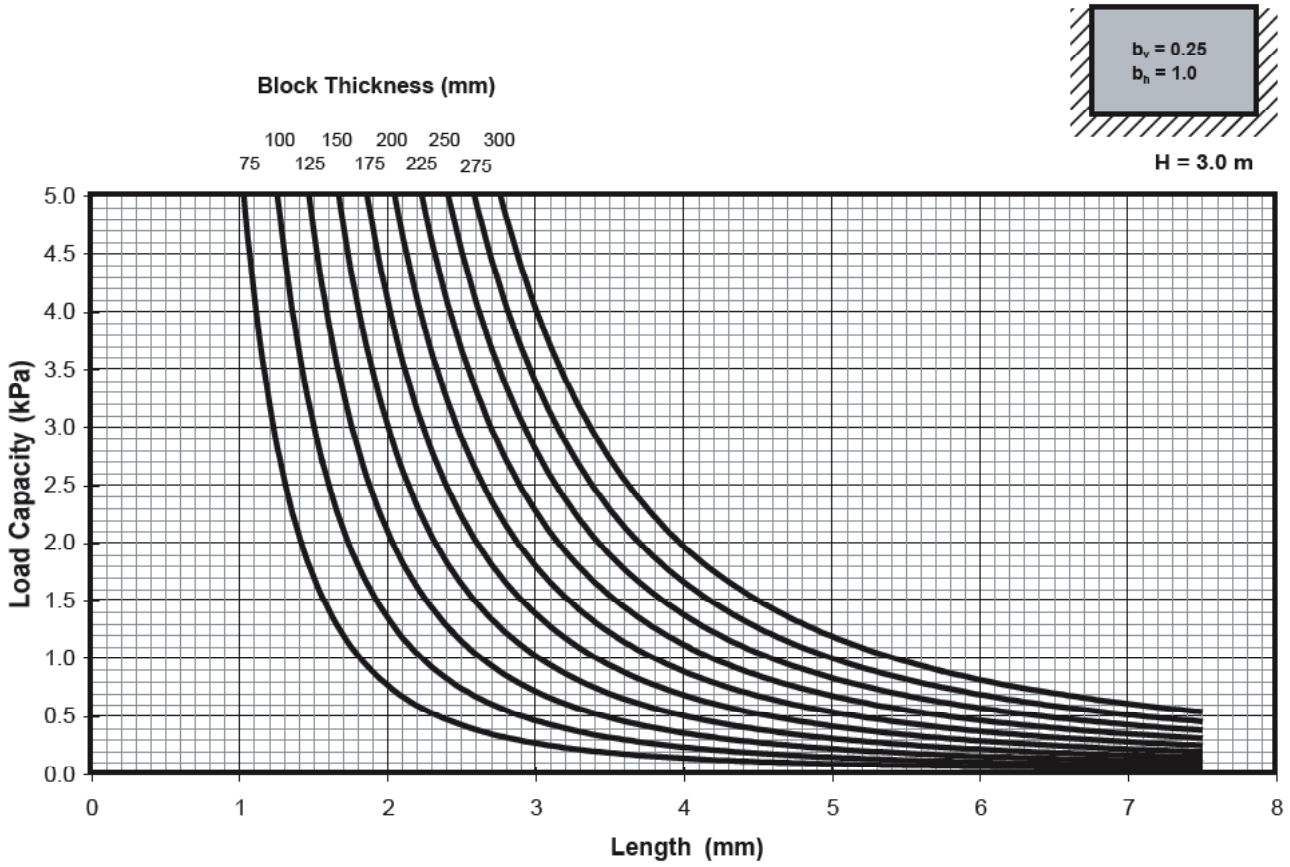
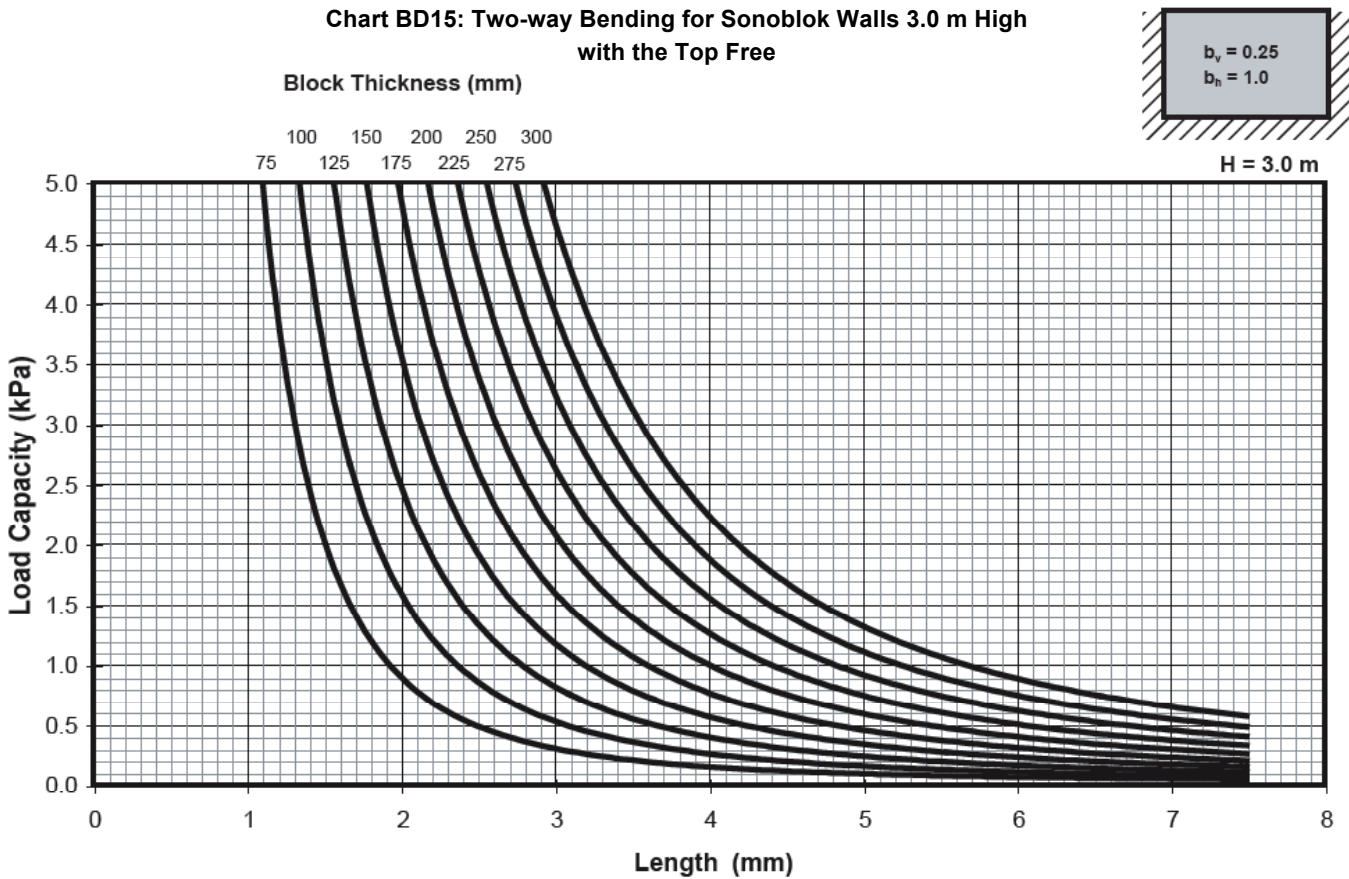

Chart BD15: Two-way Bending for Sonoblok Walls 3.0 m High with the Top Free



Section 6

6.11 Bracing Design

Overview

This section presents the design capacities and considerations necessary to design the bracing wall system for a building. The following topics are covered:

- Distribution of Bracing Walls
- Bracing Wall Construction
- Vertical reinforcement in Bracing Walls
- Horizontal Reinforcement in Bracing Walls
- Bracing Capacity – for Detail D
- Bracing Capacity Tables

General

Horizontal forces, such as wind and earthquake loading, applied to a building are to be resisted by bracing walls. Bracing walls are located generally at right angles to the walls subjected to these forces. All bracing components in the building shall be interconnected to adequately transfer the imposed loads to the footings see Figure 6.1. These connections are achieved in the following ways:

- The ceiling/floor/roof is designed to act as a diaphragm.
- The roof is appropriately held down (refer to Section 6.12: Roof-Hold Down Design).
- Wall intersections are appropriately connected (refer to Section 8 of this publication).
- The horizontal load must be transferred to footings.

To use the bracing charts, the factored lateral load should be determined in accordance with the relevant Australian standard and compared with the load capacity given by the appropriate chart for the type of anchorage. Designers can contact CSR Hebel Engineering Services for assistance when wall heights exceed 3m.

Figure 6.1: Imposed forces due to wind loads.

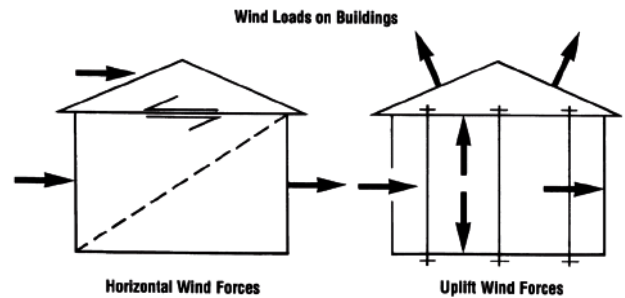

Distribution of Bracing Walls

Bracing walls shall be designed to resist the imposed loads determined in accordance with the relevant design standard, to ensure that lateral wind and earthquake forces from ceiling and floor diaphragms, and wall elements are adequately transferred into the foundations via internal and external bracing walls.

Bracing walls can be located at a maximum spacing of 8 metres. Note, the movement joint spacing (6 metres max.) may govern the bracing wall size and location.

Bracing Wall Construction

Reinforcing may be introduced into a CSR Hebel block wall in the form of threaded tie-down bolts to accommodate various design loads for bracing. Four types of wall construction are considered (Figure 6.2) and are described as follows.

1. Detail A: Walls with no hold-down bolts, resisting loads by their weight alone (only top plate connection is required).
2. Detail B: Walls with hold-down bolts in the top and bottom courses only.
3. Detail C: Walls with hold-down bolts extending from top to bottom.
4. Detail D: Walls with fully grouted vertical and horizontal reinforcement.

For all four details, the bolts or reinforcement should be inserted in a pre-drilled hole located centrally in the width of the block wall (see Section 6.18 – Construction details). CSR Hebel recommends Detail C or Detail D in high wind areas.

Figure 6.2: Hold-Down Details for Bracing Walls

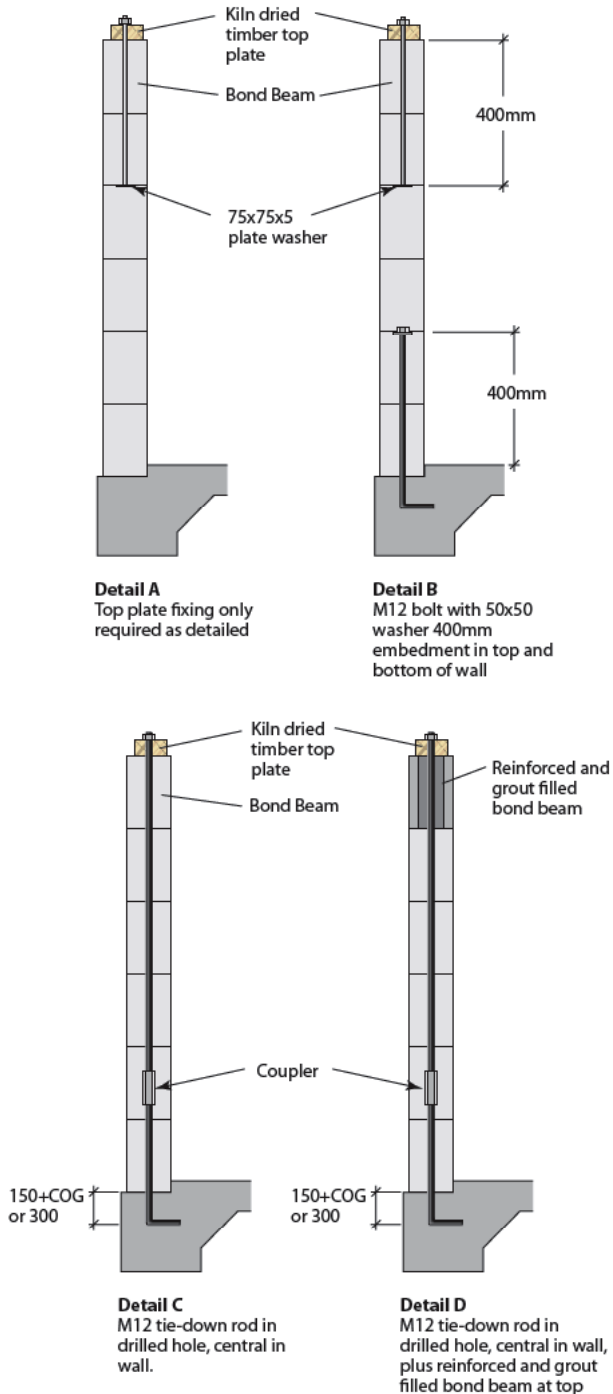

Wall Capacity – Details A, B and C

The bracing capacity of walls under shear loading depends upon the cross-sectional properties, characteristic strength of the material, dimensions of the wall, the type of anchorage to the structure and any external vertical loads acting on the wall.

Because of the variability of vertical loads, they have taken as zero in calculating the bracing capacity charts.

Detail A

Walls using Detail A are governed by overturning about the toe, resisted by the self-weight of the material. The bracing capacities of such walls are independent of height and are shown in Chart BR1 for wall thicknesses from 75mm to 300mm. Designers are also required to check the sliding capacity at the base, which is not considered in the charts, as it is a function of the vertical load and the connection of the wall to intersecting walls and other parts of the structure.

Details B & C

For walls using Detail B and Detail C there are various possible failure modes, including tensile failure of the tie-down bolt, shear failure in the CSR Hebel blocks, crushing at the toe, tensile cracking at the heel, and local crushing at the tie-down bolts. Ultimate tensile capacities of the tie-down bolts have been taken as 6.25kN for Detail B and 18.1kN for Detail C and are found not to govern in practical cases. For most cases, wall capacities are governed by dowel action of the tie-down bolts, for which the ultimate bolt capacity is 4.5kN for Detail B and 6.75kN for Detail C. A capacity reduction factor of 0.75 has been adopted – refer in AS3700 Table 4.1 'Accessories and Other Actions'.

The bracing capacities of walls using Detail B and Detail C are independent of thickness and are shown in Chart BR2 (Detail B) and Chart BR3 (Detail C) for all heights up to 3 metres.

Effect of Vertical Loading on Wall Capacity

The bracing capacities of the charts are determined assuming nil additional downwards or uplift loading. In reality an additional load from a wind loads, wall

over, roof and/or floor system will exist. These additional loads will either increase or decrease the bracing capacities given in the charts. A method for calculating the increase or reduction in bracing capacity due to additional compression or uplift loading is presented in Appendix A.

Wall Capacity – Detail D

Similar to the other details, there is various failure modes for bracing walls constructed with Detail D. This section outlines the construction of the Detail D wall, and an overview of the bracing capacity calculation and assumptions

Vertical Reinforcement in Bracing Walls

Vertical reinforcement consists of reinforcement bars centrally located in 50mm diameter holes drilled on-site through the centre of the block wall width. For Detail D, after inserting the reinforcement, the holes are then filled for the full height of the wall with a 4:1 grout mix (i.e., 4 parts sand to 1 part cement), with a characteristic compression strength of 15MPa at 28 days. The following rules apply to positioning reinforcement bars along a length of wall:

- For Detail C: spaced at a maximum horizontal distance of 1200mm.
- For Detail D: spaced at a maximum horizontal distance of 1000mm.
- Located 150mm from the ends or corners of a run of wall, such as movement joints, vertical edge of windows and door openings, and external and internal corners.

Horizontal Reinforcement in Bracing Walls

Horizontal reinforcement consists of a bond beam located at the top of the wall. Typically, the bond beam is reinforced with two reinforcement bars (12mm diameter) and filled with an aggregate grout. The grout shall have characteristic

compression strength of 25MPa at 28 days measured in accordance with the requirements for concrete in AS3600, and shall have a cement content of not less than 300kg/m³. Reinforcement is to be designed and specified by the structural design engineer. Bond beams shall be a minimum of 200 mm deep and of the same width as the block wall.

Bond beams can be easily constructed using 50mm wide AAC closure blocks fixed to the top of the blockwall with thin bed adhesive. Nominally two N12 reinforcement bars are then placed centrally in the core and grout filled.

Bracing Capacity

Bracing Design

A masonry bracing wall with wide-spaced reinforcement can fail in four ways, as follows:

1. Shear failure of the material between reinforcing bars, as for an unreinforced wall. This is resisted by the shear strength of the masonry material.
2. Overturning of the wall as a whole about its toe. This is resisted by its self-weight, any vertical load from above, and the tie-down action of the vertical reinforcing bars.
3. Sliding on the base. This is resisted by friction at the base or damp-proof course layer, and dowel action of the vertical reinforcing bars where they cross the plane at the base of the wall.
4. Shear failure of the reinforced section, where shear cracks cross the reinforcing bars. This can be considered to be resisted by an enhanced shear capacity of the material, which takes into account the presence of the reinforcing steel.

In order to perform its function properly, a reinforced masonry bracing wall must have vertical steel reinforcing rods at each end

of the wall and distributed along its length, and horizontal steel reinforcing at the top of the wall forming a bond beam. There is usually no requirement for horizontal steel at the bottom of the wall because the wall is firmly tied by the vertical steel to a slab or footing that is capable of performing the function of a bottom bond beam. The vertical and horizontal steel must be tied together to ensure proper location and action.

Development of the Bracing Capacity Tables

The bracing capacity tables in this manual give bracing capacities for a range of wall sizes and conditions.

All reinforcement has been assumed to be N12 threaded rods with a minimum yield strength of 300MPa. The maximum spacing of vertical rods is 1000mm. Dowel action strength of the vertical rods has been taken as 6.75 kN per N12 reinforcement bar.

A bond beam must be included in all walls covered by the tables. No cases are governed by reinforced shear failure, but the bond beam should be included in all walls for shrinkage control. In every case the bond beam nominally consists of two N12 reinforcing bars located in the top course of the wall and tied to vertical reinforcement (refer Section 6.18).

The following approach has been used to generate the tables for this manual:

- Shear failure of the material (criterion 1, see above) has been checked using the approach of AS3700 (Clause 7.5.1(b)) but never governs for the range covered in the tables.
- Shear failure of the reinforced material (criterion 4, see above) has been checked using the approach of AS3700 (Clause 8.6) but never governs for the range covered in the tables.
- Overturning of the wall (criterion 2, see above) was checked and the load capacity calculated. This condition tends to govern for cases where the wall is relatively tall and short (with height/length greater than about 1).
- Sliding on the base (criterion 3, see above) was checked and the load capacity calculated. This condition tends to govern for cases where the wall is relatively long (with height/length less than about 1).

Designers can treat cases outside the range covered by the tables. In particular, this would be necessary when accounting for the effects of vertical load. However, if this is done, all four failure criteria set out above must be checked. Failure modes 1 and 4 can be checked by using the method given in AS3700 or another suitable approach. The approaches used to analyse failure modes 2 and 3 are set out below.

Design Procedure for Overturning

For the tables in this manual, calculation of the overturning capacity has been carried out by an analysis of the wall as a reinforced section cantilevered from the base. A capacity reduction factor of 0.75 has been used. Calculation of equilibrium for the section is based on a linear strain distribution and a maximum tensile strain in the extreme reinforcing bar of 0.0015. Figure 6.3 shows how the equilibrium of the section is determined. The rectangular stress block is taken to have a width of 0.85 times the depth to the neutral axis and a maximum stress of 0.85 times the characteristic compressive strength of the AAC masonry, f_m .

Once the position of the neutral axis is determined, the overturning capacity is calculated by considering the moment generated by the compression stress block (ignoring any reinforcement in compression) and the reinforcement in the tension zone.

A more detailed analysis for individual cases would take account of any imposed load from above and the effect of any bonding of the wall to intersecting walls.

Design Procedure for Sliding

Analysis of the sliding capacity is based on a similar analysis of the reinforced section as illustrated in Figure 6.3, with a linear strain distribution through the section and a maximum tensile strain in the extreme reinforcing bar of 0.0015. As for overturning, the rectangular stress

block is taken to have a depth of 0.85 times the depth to the neutral axis, and a compressive stress level of $0.85 f'_m$.

Once the position of the neutral axis is determined, the sliding resistance is calculated as the sum of a friction component on the compression stress block and the dowel action of the bars. For the tables in this manual, the friction coefficient has been taken as 0.3 in accordance with AS3700 (Table 3.3). A capacity reduction factor of 0.75 has been used.

Figure 6.3. Equilibrium Calculation for Forces at Base of Bracing Wall

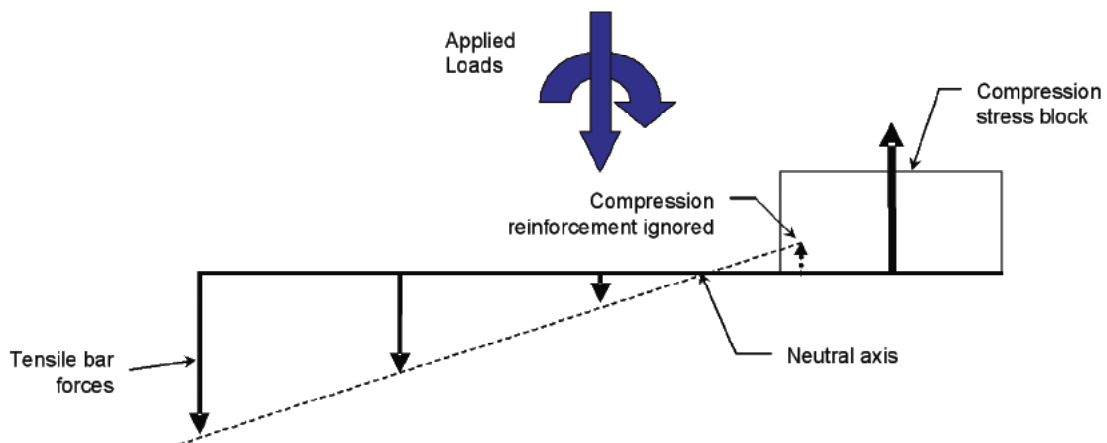

Chart BR1: Ultimate Bracing capacities for walls using Detail A (Applied Vertical Load = 0 kN/m)

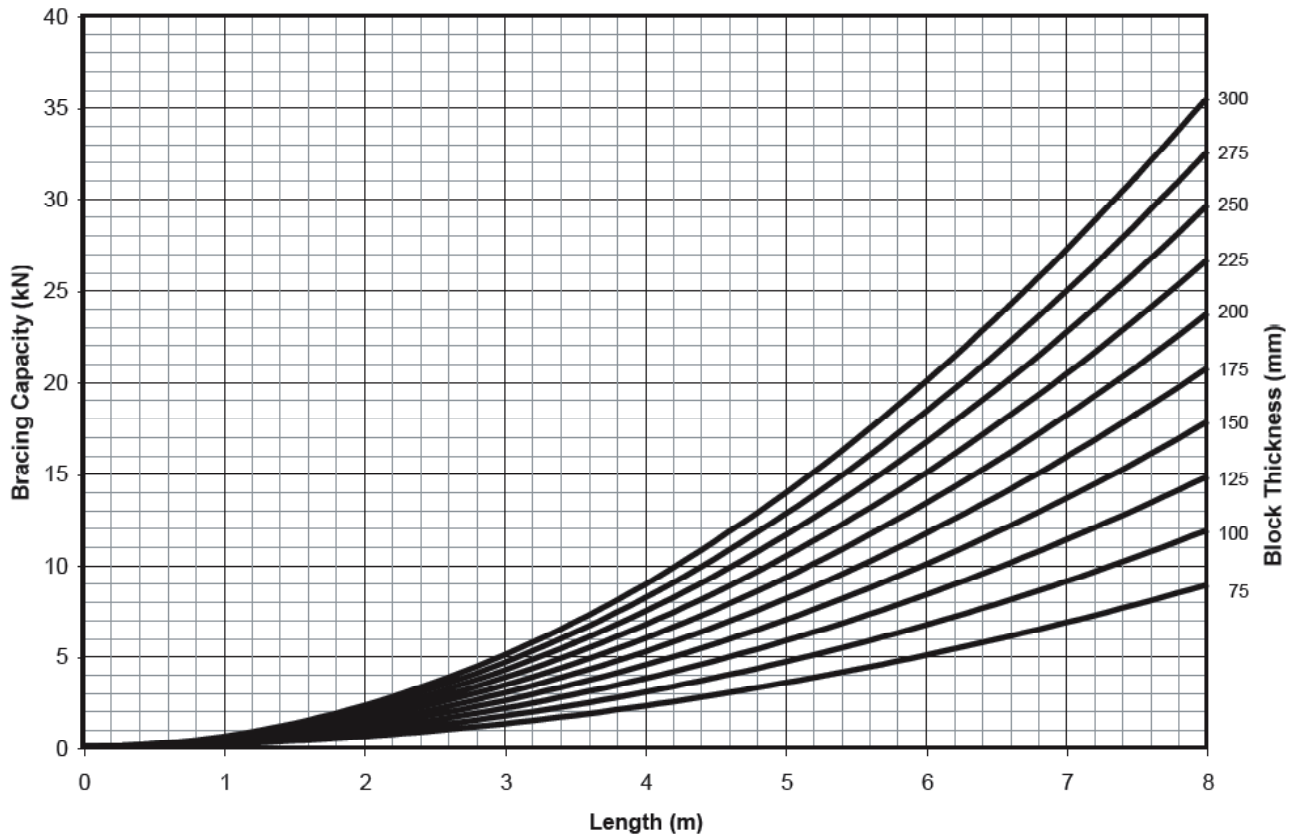

Chart BR2: Ultimate Bracing Capacities for Walls Of Any Thickness and Height Up To 3 m, Using Detail B – Tie-down Bolts at 1200 mm Centres (Applied Vertical Load = 0 kN/m)

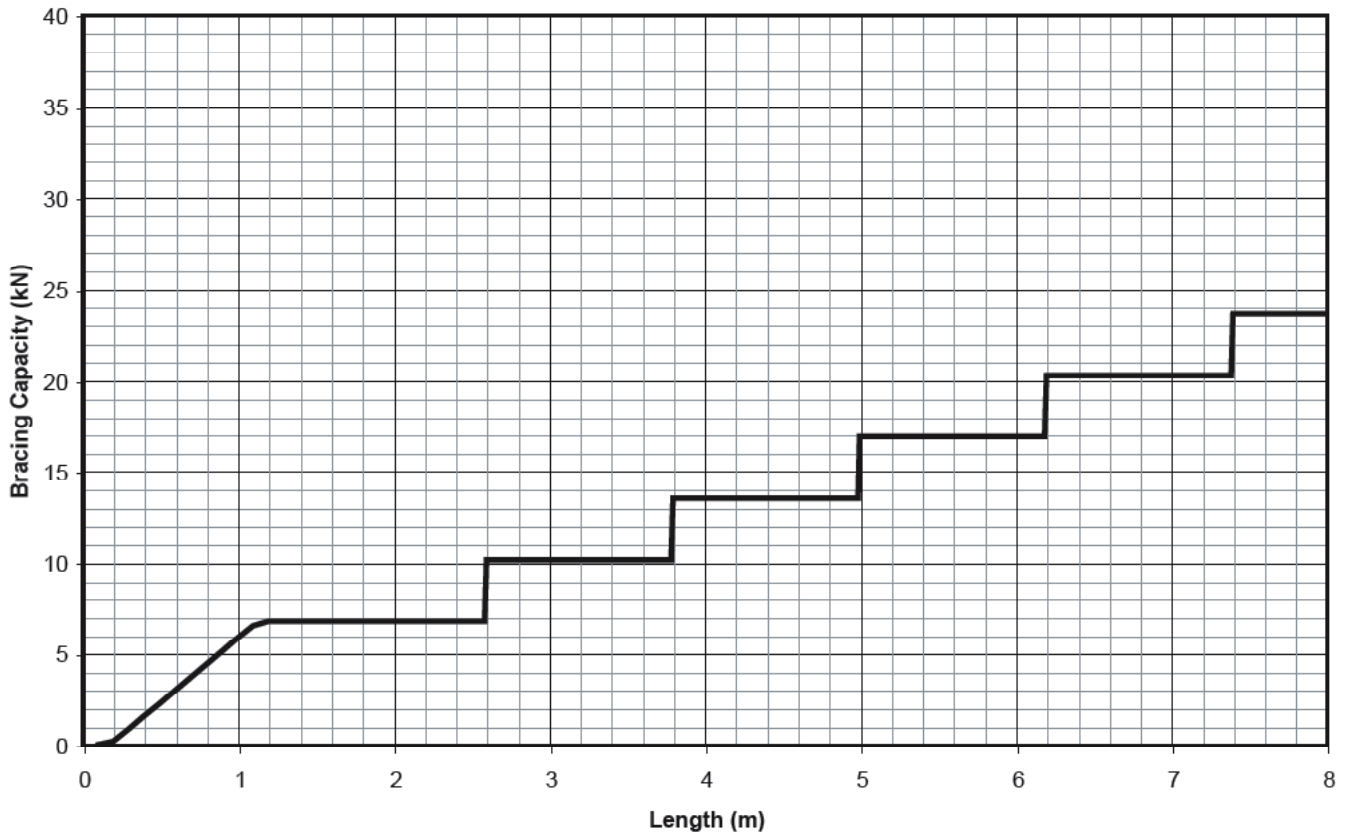

Chart BR3: Ultimate Bracing Capacities for Walls Of Any Thickness and Height Up To 3 m,
Using Detail C – Tie-down Bolts at 1200 mm Centres (Applied Vertical Load = 0 kN/m)

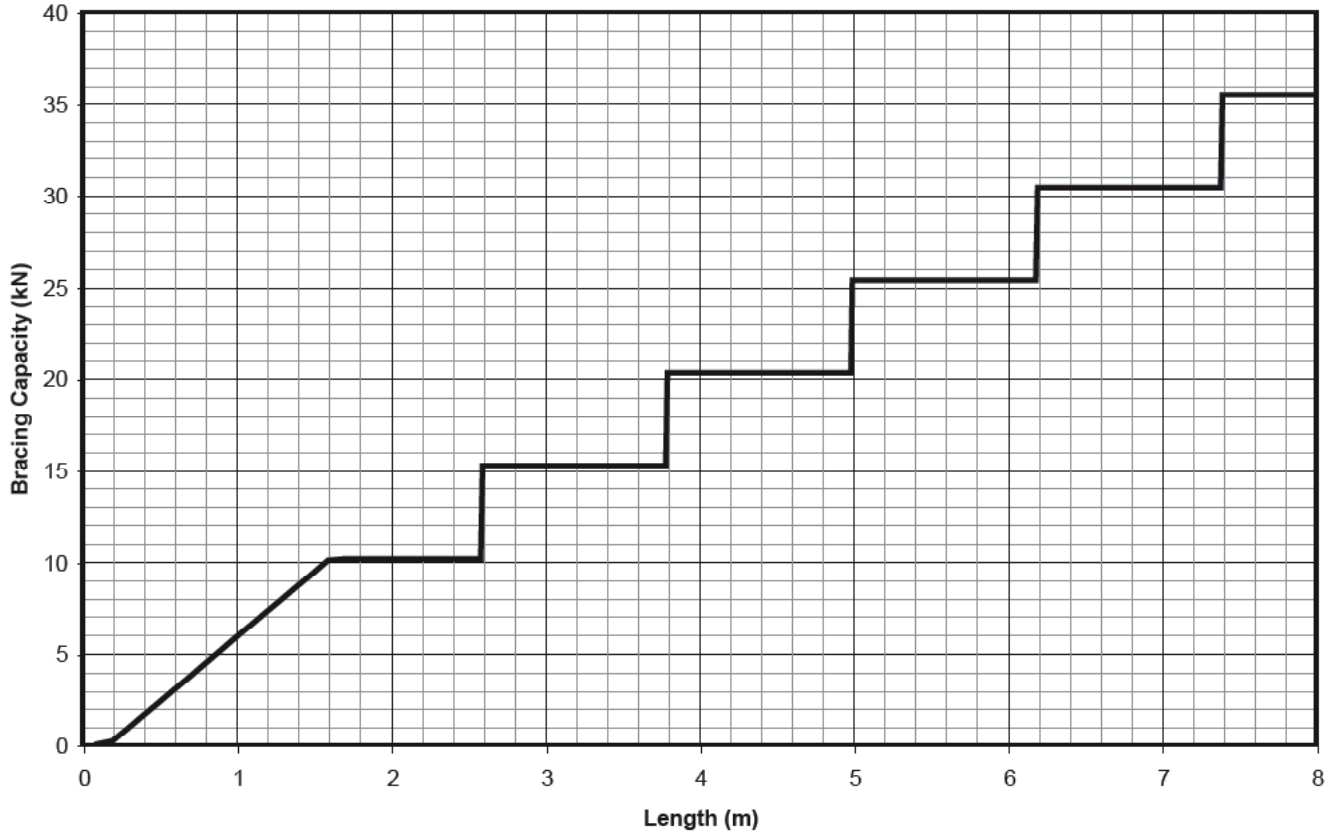

Table 6.6: - Ultimate bracing capacities for 150mm thick walls using Detail D

Height (mm)	Ultimate Bracing Capacity (kN)									
	Wall Length (mm)									
	900	1200	1800	2400	3000	3600	4200	4800	5400	6000
	(2 # N12)	(2 # N12)	(3 # N12)	(3 # N12)	(4 # N12)	(5 # N12)	(5 # N12)	(6 # N12)	(6 # N12)	(7 # N12)
1200	13	18	26	27	35	44	44	53	53	62
1400	11	17	27	27	36	44	44	53	53	62
1600	10	15	27	27	36	44	45	53	54	62
1800	9	13	27	27	36	44	45	54	54	63
2000	8	12	25	27	36	45	45	54	54	63
2200	7	11	22	27	36	45	45	54	54	63
2400	7	10	21	27	36	45	45	54	54	63
2600	6	9	19	27	36	45	45	54	55	63
2800	6	8	18	25	36	45	45	54	55	64
3000	5	8	16	24	36	45	46	54	55	64

Note: Bracketed information indicates minimum number of vertical reinforcement bars required

Table 6.7: - Ultimate bracing capacities for 200mm thick walls using Detail D

Height (m)	Ultimate Bracing Capacity (kN)									
	Wall Length (mm)									
	900	1200	1800	2400	3000	3600	4200	4800	5400	6000
	(2 # N12)	(2 # N12)	(3 # N12)	(3 # N12)	(4 # N12)	(5 # N12)	(5 # N12)	(6 # N12)	(6 # N12)	(7 # N12)
1200	14	18	27	27	36	45	45	54	54	63
1400	12	18	27	27	36	45	45	54	54	63
1600	10	15	27	27	36	45	45	54	54	63
1800	9	14	27	27	36	45	45	54	55	64
2000	8	12	26	27	36	45	46	55	55	64
2200	7	11	23	28	37	46	46	55	55	64
2400	7	10	21	28	37	46	46	55	55	64
2600	6	9	20	28	37	46	46	55	56	65
2800	6	9	18	26	37	46	46	56	56	65
3000	5	8	17	25	37	46	47	56	56	65

Note: Bracketed information indicates minimum number of vertical reinforcement bars required

Table 6.8: - Ultimate bracing capacities for 250mm thick walls using Detail D

Height (mm)	Ultimate Bracing Capacity (kN)									
	Wall Length (mm)									
	900	1200	1800	2400	3000	3600	4200	4800	5400	6000
	(2 # N12)	(2 # N12)	(3 # N12)	(3 # N12)	(4 # N12)	(5 # N12)	(5 # N12)	(6 # N12)	(6 # N12)	(7 # N12)
1200	14	19	27	27	36	45	45	54	55	63
1400	12	18	27	27	36	45	46	55	55	64
1600	11	16	27	28	37	46	46	55	55	64
1800	10	14	28	28	37	46	46	55	55	65
2000	9	13	26	28	37	46	46	55	56	65
2200	8	11	24	28	37	46	47	56	56	65
2400	7	10	22	28	37	46	47	56	56	66
2600	7	10	20	28	37	47	47	56	57	66
2800	6	9	19	27	38	47	47	57	57	66
3000	6	8	18	25	38	47	48	57	57	67

Note: Bracketed information indicates minimum number of vertical reinforcement bars required.

Table 6.9: - Ultimate bracing capacities for 300mm thick walls using detail D

Height (mm)	Ultimate Bracing Capacity (kN)									
	Wall Length (mm)									
	900	1200	1800	2400	3000	3600	4200	4800	5400	6000
	(2 # N12)	(2 # N12)	(3 # N12)	(3 # N12)	(4 # N12)	(5 # N12)	(5 # N12)	(6 # N12)	(6 # N12)	(7 # N12)
1200	15	19	28	28	37	46	46	55	55	64
1400	13	18	28	28	37	46	46	55	55	64
1600	11	16	28	28	37	46	46	55	56	65
1800	10	14	28	28	37	46	47	56	56	65
2000	9	13	27	28	37	47	47	56	57	66
2200	8	12	25	28	38	47	47	56	57	66
2400	7	11	23	29	38	47	48	57	57	67
2600	7	10	21	29	38	47	48	57	58	67
2800	6	9	20	28	38	48	48	57	58	67
3000	6	9	18	26	38	48	48	58	58	68

Note: Bracketed information indicates minimum number of vertical reinforcement bars required.

6.12 Roof Hold-Down Design

Uplift forces exerted on roofs by wind are transferred into the walls through the connection of the top plate using hold down anchors. See Section 8 for ultimate capacities of fixings.

It is recommended that the holes drilled in the top plate for an anchor to be oversized by at least 2mm should allow possible timber movement. The following tables have been compiled for wind loads N2, N3, C1 and C2.

The uplift capacities in the following tables are the capacity values for the fixing into the CSR Hebel wall. The project structural engineer is responsible for checking the capacities of the connection to the roof structure and other framing, including the top plate.

Table 6.10: Tie Down Assumptions

1. The following permissible wind uplift loads have been used:	
Ramset Hema Nail, 8mm x 100mm embedment	0.5kN
Hilti HGN Anchors, 10mm diameter	0.5kN
Fisher Nylon Twist Lock Anchor GB8	0.2kN
Fisher Nylon Twist Lock Anchor GB10	0.3kN
Fisher Nylon Twist Lock Anchor GB14	0.5kN
Power Fasteners Mungo. MB-S 10 x 300	1.1kN
M12 bolt rod & 50x50x5mm washer (Detail B)	2.35kN
M12 tie-down rod with $f_{sy} \geq 300\text{MPa}$ (Detail C)	12.1kN
Acfix - 380	2.17kN
Beware of using these capacities when fixings are near short lengths of wall between openings.	
In these cases the wall capacity may well govern the wall design.	
2. Top plates have been assumed to be continuous over at least two spans between tie down points. Truss spacing has been taken as 1200mm for sheet roofs and 600mm for tile roofs.	
3. The following net design pressures acting on a roof have been determined using the permissible stress method ($W_p - 0.75G$), in accordance with AS4055-1992:	
N2 Sheet	0.42kPa
N2 Tile	Nil
N3 (non-cyclonic) Sheet	0.81kPa
N3 (non-cyclonic) Tile	0.44kPa
C1 (cyclonic) Sheet	1.31kPa
C1 (cyclonic) Tile	0.94kPa
C2 Sheet	2.10kPa
C2 Tile	1.73kPa
C3 Sheet	3.16kPa
C3 Tile	2.79kPa
4. All walls are assumed to be constructed from Hebel Block (525kg/m^3)	

Table 6.11: Roof Tie Down – N2 and N3 (Non-cyclonic)

Nº.	Tie-Down Detail	Maximum Allowable Load Width (m)				
		Spacing (mm)	N2 Sheet	N2 Tile	N3 Sheet	N3 Tile
1	Ramset Hema Nail, 8mmx100mm embedment	600	4.3	9.5	2.4	3.5
2	Hilti HGN Anchor, 8mm dia. coach screw	600	2.8	6.1	1.6	2.2
5	Fisher Nylon Twist Lock Anchor GB14	1200	#N/A	#N/A	#N/A	#N/A
5	Fisher Nylon Twist Lock Anchor GB14	600	#N/A	2.3	#N/A	#N/A
6	Mungo Power Fastener MB-S 10x300	600	4.7	10.1	2.6	3.7
9	Mechfast Acfix 380	1200	2.3	5.0	#N/A	1.8
7	M12 rod & 50x50x5mm washer (Detail B)	2400	3.3	7.2	1.8	2.6
7	M12 rod & 50x50x5mm washer (Detail B)	1800	4.4	9.6	2.5	3.5
7	M12 rod & 50x50x5mm washer (Detail B)	1200	6.6	14.4	3.7	5.3
8	M12 tie-down rod (Detail C)	2400	6.4	13.9	3.6	5.1
8	M12 tie-down rod (Detail C)	1800	8.5	Any	4.7	6.8
8	M12 tie-down rod (Detail C)	1200	12.8	Any	7.1	10.2

Table 6.12: Roof Tie Down – C1 and C2 (Cyclonic)

Nº.	Tie-Down Detail	Maximum Allowable Load Width (m)				
		Spacing (mm)	C1 Sheet	C1 Tile	C2 Sheet	C2 Tile
1	Ramset Hema Nail, 8mmx100mm embedment	600	1.5	1.9	#N/A	#N/A
2	Hilti HGN Anchor, 8mm dia. coach screw	600	#N/A	#N/A	#N/A	#N/A
5	Fisher Nylon Twist Lock Anchor GB14	1200	#N/A	#N/A	#N/A	#N/A
5	Fisher Nylon Twist Lock Anchor GB14	600	#N/A	#N/A	#N/A	#N/A
6	Mungo Power Fastener MB-S 10x300	600	1.7	2.1	#N/A	#N/A
9	Mechfast Acfix 380	1200	#N/A	#N/A	#N/A	#N/A
7	M12 rod & 50x50x5mm washer (Detail B)	2400	#N/A	#N/A	#N/A	#N/A
7	M12 rod & 50x50x5mm washer (Detail B)	1800	1.6	1.9	#N/A	#N/A
7	M12 rod & 50x50x5mm washer (Detail B)	1200	2.4	2.9	1.5	1.7
8	M12 tie-down rod (Detail C)	2400	2.3	2.8	#N/A	1.7
8	M12 tie-down rod (Detail C)	1800	3.0	3.8	1.9	2.2
8	M12 tie-down rod (Detail C)	1200	4.6	5.6	2.9	3.3

Associated CSR Hebel Products

6.13 Lintels

CSR Hebel lintels are reinforced sections similar to panels. The lintels are used as supports over doorways, windows and other openings.

Lintels shall be installed so that the surface marked 'THIS SIDE UP' is uppermost, as the section reinforcement may not be symmetrical. All lintels are not to be cut on-site. Table 6.13 outlines the minimum bearing lengths at each end of the CSR Hebel lintel.

Where possible the bearing block should extend past the end of the lintel. Table 6.14 presents the range of standard CSR Hebel lintels and the associated capabilities.

Lintels are available in standard block widths of 100mm, 150mm and 200mm and lengths up to 3000mm. Refer to the lintel Table 6.14 over for standard working loads (consisting of 60% dead load + 40% live load). For larger spans or higher loads, use structural steel lintels as designed by the project structural engineer.

Where lintels are designed for uplift, 60% of the available loading shown in the table may be used.

Table 6.13: Minimum bearing lengths of lintels

Clear Span	Bearing Length
<1000	150mm
1000-1900	200mm
1900-3000	300mm
>3000mm	to Engineer's Design

Table 6.14: Working Loads for Standard CSR Hebel Lintels

Product Code	Maximum Opening (mm)	Minimum Bearing (mm) both ends	Length (mm)	Height (mm)	Thickness (mm)	Weight (kg)	Allowable Working load kN/m, Fire Resistance Rating, FRL minutes					
							0	60	90	120	180	240
							22046	900	150	1200	300	100
22047	900	150	1200	300	150	48	17.0	17.0	17.0	17.0	17.0	17.0,
22048	900	150	1200	300	200	64	17.0	17.0	17.0	17.0	17.0	17.0,
22038	1500	200	1900	300	100	50	12.5	10.6	10.2	9.3	6.5	4.5,
22039	1500	200	1900	300	150	75	17.0	16.0	15.8	15.4	8.7	6.2,
22040	1500	200	1900	300	200	100	17.0	17.0	17.0	16.9	8.8	6.3,
22041	1800	200	2200	300	100	58	8.9	8.2	8.0	7.8	4.2	3.1,
22042*	1800	200	2200	300	150	87	10.9	10.0	9.9	9.6	5.7	4.7,
22043	2400	300	3000	400	100	105	9.3	8.5	8.1	7.4	4.4	3.6,
22044	2400	300	3000	400	150	158	12.6	11.8	11.6	11.4	6.5	5.5,
22045*	5000	*	6000	600	200	632	4.8	4.5	4.4	4.3	2.4	2.0,

These allowable working loads consist of 60% dead load and 40% live load.

* These lintels should only support loads from single storey construction unless certified by a practising structural engineer.

These lintels satisfy the clear span / 800 deflection criteria for the short-term serviceability loading case, i.e., dead load + 70% live load

6.14 'U' Sections

'U' sections for lintels and bond beams can be formed on site with 50mm blocks. Reinforcing steel and concrete are added to these sections to produce lintel substitutes and bond beams.

A practicing structural engineer should be consulted concerning the number and diameter of reinforcing bars to be used to a particular application.

6.15 Stair Treads and Stair Panels

Standard stair treads are available in 175mm thickness, 300mm wide and lengths of 1000 or 1200 mm. Each tread should overlap the tread below by 50mm and be supported at each end by 50mm minimum bearing.

Stair panels are also available in thickness of 150 or 175mm, 600mm wide and length of 6000mm. These panels are reinforced to allow the cutting of required lengths and widths on-site. These are designed for a live load of 3 kPa for spans up to 3.0m.

The reinforcing which is exposed at the cut must be coated with CSR Hebel protective paint.

Stair layouts which require sharp corners on the treads require a metal angle on the leading edge.

On-site Considerations

6.16 On-site Handling

The following are common issues requiring consideration and resolution in the application of AAC masonry to individual projects:

- Health and Safety
- Manual Handling
- Unloading Block Pallets
- Storage
- Personal Protective Equipment, PPE
- Cutting
- Installation Procedures
- Damaged Panels
- Mortars and Adhesives
- Waterproof Membrane

Health and Safety

CSR Hebel products are cement-based, which may irritate the skin, resulting in itching and occasionally a red rash. The wearing of gloves and suitable clothing to reduce abrasion and irritation of the skin is recommended when handling CSR Hebel products.

Approved respirators (AS/NZS1715 and AS/NZ1716) and eye protection (AS1336) should be worn at all times when cutting and chasing. Refer to the appropriate CSR Hebel Material Safety Data Sheet.

Manual Handling

CSR Hebel recommends using a trolley or other mechanical apparatus to move the panels around the work site. Manual handling where people physically move a panel, should be kept to a minimum, with the weight being supported by an

individual kept as small as possible. Any concerns regarding the weight to be handled should be discussed with the panel installation contractor.

To minimise the possibility of manual handling injuries, CSR Hebel suggests the following:

1. Use mechanical aids, such as trolleys, forklifts, cranes and levers, or team lifting to move panels.
2. Keep the work place clean to reduce the risk of slips, trips and falls, which can cause injury.
3. Plan the sequence of installation to minimise panel movements and avoid awkward lifts.
4. Train employees in good lifting techniques to minimise the risk of injury.

Unloading Block Pallets

Block Pallets shall be unloaded and moved with only approved lifting devices. Note: Pallets of CSR Hebel blocks may require a block cage when lifting above certain heights. Before use, the lifting devices (block cage) should be checked for the required lifting tags. The pallets should be unloaded as close as possible to the intended installation area. This will increase work efficiency and minimise the need for secondary handling.

Note: Secondary handling increases the risk of block damage. The repair of damage sustained during lifting and moving is the responsibility of the lifter. When damage is excessive, the product should be replaced.

Storage

All materials must be kept dry and preferably stored undercover. Care should be taken to avoid sagging or damage to ends, edges and surfaces. All CSR Hebel panel and lintel products must be stacked on edge and properly supported off the ground, on a level platform. Panel bundles can be stacked two high. The project

engineer should be consulted as to the adequacy of the structure to support the stacked bundles.

Only single bundles positioned on the ground can be opened. To provide a level surface, we recommend placing temporary joists beneath the supporting cleats.

Personal Protective Equipment, PPE

CSR Hebel products are cement-based, and may irritate the skin resulting in itching and occasionally a red rash. The wearing of gloves and suitable clothing to reduce abrasion and irritation of the skin is recommended when handling CSR Hebel products.

Cutting

The use of power tools may cause dust, which contains respirable crystalline silica, with the potential to cause bronchitis, silicosis and lung cancer after repeated and prolonged exposure. When using power or hand tools, on CSR Hebel products, wear a P1 or P2 respirator and eye protection. When cutting, routing or chasing CSR Hebel products with power tools, use dust extraction equipment and wear hearing protection. Refer to CSR Hebel MSDS sheets. For further information, contact CSR Hebel or visit the website.

Installation Procedures

CSR promotes and advocates a safety conscious work place at all times. To assist builders and contractors to maintain their safety standards, CSR Hebel has produced guidelines for the installation and handling of their products.

These guidelines can be found in the following technical bulletins;

- CSR Hebel PowerPanel' Installation & Handling Guidelines, No HTB791,
- CSR Hebel Wall Panel Installation & Handling Guidelines, No HTB799, and

Damaged Panels

CSR Hebel should be notified immediately of any block damage or cracking at occurs during the handling of the blocks. This damage may result in the block being structurally inadequate, and should be replaced.

Mortars and Adhesives

The CSR Hebel bagged mortar and adhesive should be prepared in accordance with instructions on the packaging.

Waterproof Membrane

Waterproofing membranes shall be nominated by the designer or specifier, and installed in accordance with manufacturer's recommendations.

6.17 Installation

CSR Hebel blocks are delivered to site strapped and shrink wrapped to pallets. Where possible the CSR Hebel blocks should be placed on level ground, as near as possible to where they will be used. Secondary handling should be avoided.

In the case of blocks and panels appropriate lifting and handling equipment should be used to unload the trucks and to lift products into position, as this handling equipment have been designed to minimise product damage.

Both panels and blocks should be kept dry before use. Shrink wrapping should not be removed until just prior to use. A cap of plastic should be retained to cover the top surface of the remaining blocks. Top surfaces of blocks and panels should be protected to prevent ponding of water during rain and blocks should not be laid in the rain.

Installation of Blocks

CSR Hebel blocks are laid using premixed Hebel Adhesive. Refer to the 'Wall

Construction Checklist' for guidance on construction issues to be considered (see Figure 6.5). The Hebel Adhesive should be prepared in accordance with the instructions on the packaging. Importantly, the adhesive should not be retempered as this will have a detrimental affect on the bond strength

After thoroughly mixing the adhesive is ready for use.

Laying the First Course

A membrane Damp-Proof Course (DPC) which prevents rising damp and acts as a slip joint/bond breaker must be installed between the first course and the foundations or slab on all internal and external walls to allow for differential movement between the block and the supporting structure. The first course should be bedded on Hebel Mortar to compensate for irregularities in the foundation slab. The Hebel Adhesive is applied to the vertical block surfaces (perpend joints). It is essential that the first course be laid correctly and level, so that speed and accuracy can be achieved with the adhesive in subsequent courses.

Subsequent Courses

All blocks should be brushed clean of dirt and loose particles. Hebel Adhesive is then applied to the vertical and horizontal surfaces using a CSR Hebel trowel of the same width as the blocks. Vertical and horizontal joint thickness should be approximately 2-3mm.

The consistency of the adhesive should be such that it flows easily through the teeth of the trowel. When applied, the ribs of adhesive should maintain their shape and not collapse. A thin mix will result in poor joint strength and is indicated by collapsing ribs. A dry mix will result in the ribs not bonding to the AAC surface and

peeling off the block. The adhesive must cover the whole vertical and horizontal surface of the block to maintain wall strength, sound and fire rating.

All perpend should be fully covered with the adhesive, made tight and a full contact achieved.

Figure 6.4 – Laying Blocks



Excess adhesive should be removed from the block face as laying proceeds.

The vertical joint of the lower course must be staggered at least 100mm relative to the vertical joint of the overlaying course. A rubber mallet is used to align the blocks. (See Figure 6.4)

The CSR Hebel Hand Saw or use of an electric saw can be used to easily cut the blocks to the correct length at the end of the course. Similarly, mitres and curved profiles are possible with CSR Hebel blocks. The blocks should not be pre-wet before use.

If the necessary wall height, cannot be achieved using standard size blocks, then compensating blocks can easily be cut for the final course.

A 'Wall Construction Checklist' is shown in Figure 6.5. When chasing non-fire rated walls (for services etc.), the maximum depth of chase is 1/3 of the wall thickness. Refer to Section 5 of this publication for

information on Fire Design and Chasing. Patching of chases should be done with Hebel Patch or other proprietary proven patching compounds. Reinforcing mesh can be placed over the patched area to reduce the possibility of cracking in the finish.

IMPORTANT:

Water services/hydraulic services should not be located in chasings. These services should be installed in accordance with BCA recommendations.

Horizontal Surfaces

CSR Hebel does not recommend a horizontal surface finish of its products in external environments. As water could pond on the surface and penetrate the coating system. In the case of a horizontal finish, CSR Hebel recommends that the surface be treated with a waterproof membrane or metal flashing/capping. The designer should ensure that the waterproof membrane is compatible with coatings, finishes, environment conditions, AAC substrate, etc.

The main areas to detail correctly are roof and floor panels, window sills and the top of parapets.

Importantly, the AAC substrate should be prepared in accordance with the membrane manufacturer's instructions.

Figure 6.5: Wall Construction Checklist

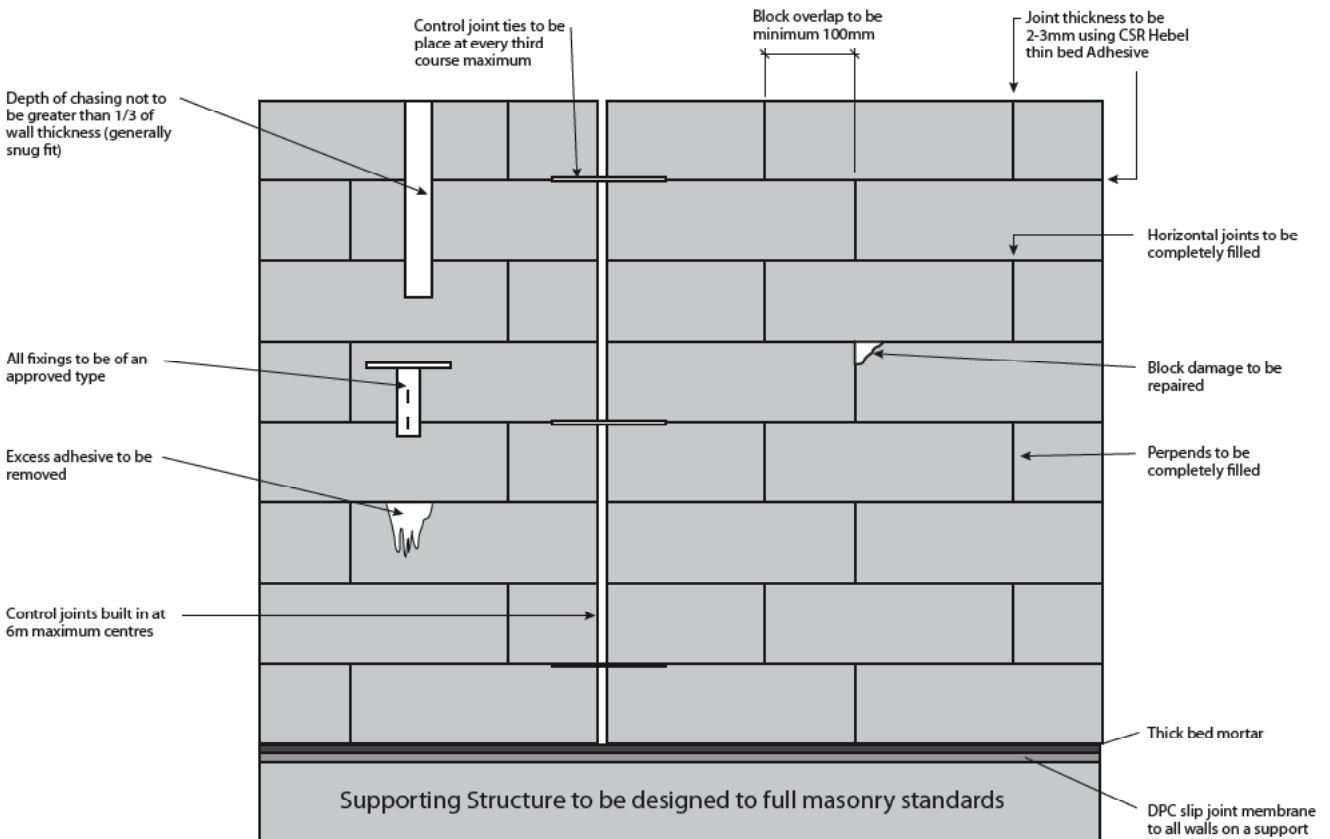

Section 6

Lintels

It is recommended that lintels be seated on a full block (600x200mm face dimension) and bonded by bedding on Hebel Adhesive. Where required, use a sanding float or levelling plane to achieve a level bedding surface. It is recommended that where an opening forms part of a movement joint, one end of the lintel be seated on a slip joint, to accommodate any movements due to material shrinkage, foundation movement, etc.

If walls are to be rendered or plastered, it is recommended that fibreglass mesh reinforcing be applied in the coating across the bonded ends of the lintels, and at the corners of all doors and windows.

Lintels must never be cut. Blockwork at each end of the lintel should be built to accommodate the delivered size of the lintel.

It is recommended that all lintels delivered to site be stored under cover and in a dry location to maintain compatible moisture content to the blocks.

Chimneys and Fire Places

Special attention to detailing is necessary when using CSR Hebel block products in fire places and chimneys. Because cement based products can, over long periods, be attacked by carbon dioxide, a fire resistant lining or firebox should be used in the chimney. Metal fire places should not be in contact with block work and sufficient clearance to allow for thermal expansion of the metal must be included.

6.18 Construction Detailing – Block Construction

Index of Construction Detail Drawings		
Detail	Title	Page
1.0	Isometric Concept House	6.58
2.1	Hebel Blockwork on Stiffened Raft Slab Edge	6.59
2.2	Internal Load Bearing Hebel Blockwork on Stiffened Raft Slab Foundation	6.60
3.1	Hebel Blockwork Typical Movement Joint Detail-Elevation View	6.61
3.1.1	Hebel Blockwork Typical Movement Joint Detail-Plan View	6.61
3.2	Hebel Blockwork Movement Joint Detail -Elevation View	6.62
3.2.1	Hebel Blockwork Movement Joint Detail - Plan View	6.62
4.1	External Wall and Internal Bracing Wall Junction-Plan View	6.63
4.2	External Wall and Internal Wall Junction -Plan View	6.63
4.3	External Wall and Internal Bracing Wall Junction -Plan View	6.64
4.4	External Wall and Internal Timber/Steel Stud Wall Junction-Plan View	6.64
4.5	Hebel Blockwork and Concrete Wall/Column Junction-Plan View	6.65
4.6	No Load Bearing Hebel Block Wall and Beam/Slab Junction	6.65
5.1	Hebel Block Wall and Floor Panel Junction Detail	6.66
5.2	Hebel Block Wall and Timber Floor Frame Junction	6.66
5.3	Internal Hebel Wall and Timber Floor Frame Junction	6.67
5.4	External Hebel Wall and Reinforced Concrete Slab Junction	6.67
6.1	Roof Top Plate Fixing to Hebel Wall	6.68
6.2	Truss Spanning Over Non-Load Bearing Hebel Walls	6.68
6.3	Roof Top Plate Fixing to Hebel Wall	6.69
6.4	Timber Truss/Joist Fixed to Hebel Wall	6.69
6.5	Vaulted Ceiling & Roof Plate Fixing to Hebel Wall	6.70
6.6	Gable End Roof Fixing to Hebel Wall	6.71
6.7	Tiled Roof Eve and Hebel Wall Junction	6.72
6.8	Timber Awning and Hebel Wall Junction	6.73
7.1	Steel Door Frame (Internal or External) to Hebel Wall Fixing	6.74
7.2	Steel Door Frame (Internal or External) to Hebel Wall Fixing	6.74
7.3	Timber Door Frame (External) to Hebel Wall Fixing	6.75
7.4	Timber Door Frame (Internal) to Hebel Wall Fixing	6.75
7.5	Aluminium Window Frame-Window Sill Detail	6.76
7.6	Aluminium Window Frame-Window Side Detail	6.76
7.7	Aluminium Window Frame-Window Head Detail	6.77
7.8	Timber Window Frame-Window Sill Detail	6.77
7.9	Timber Window Frame-Side Frame Detail	6.78
7.10	Timber Window Frame-Window Head Detail	6.78

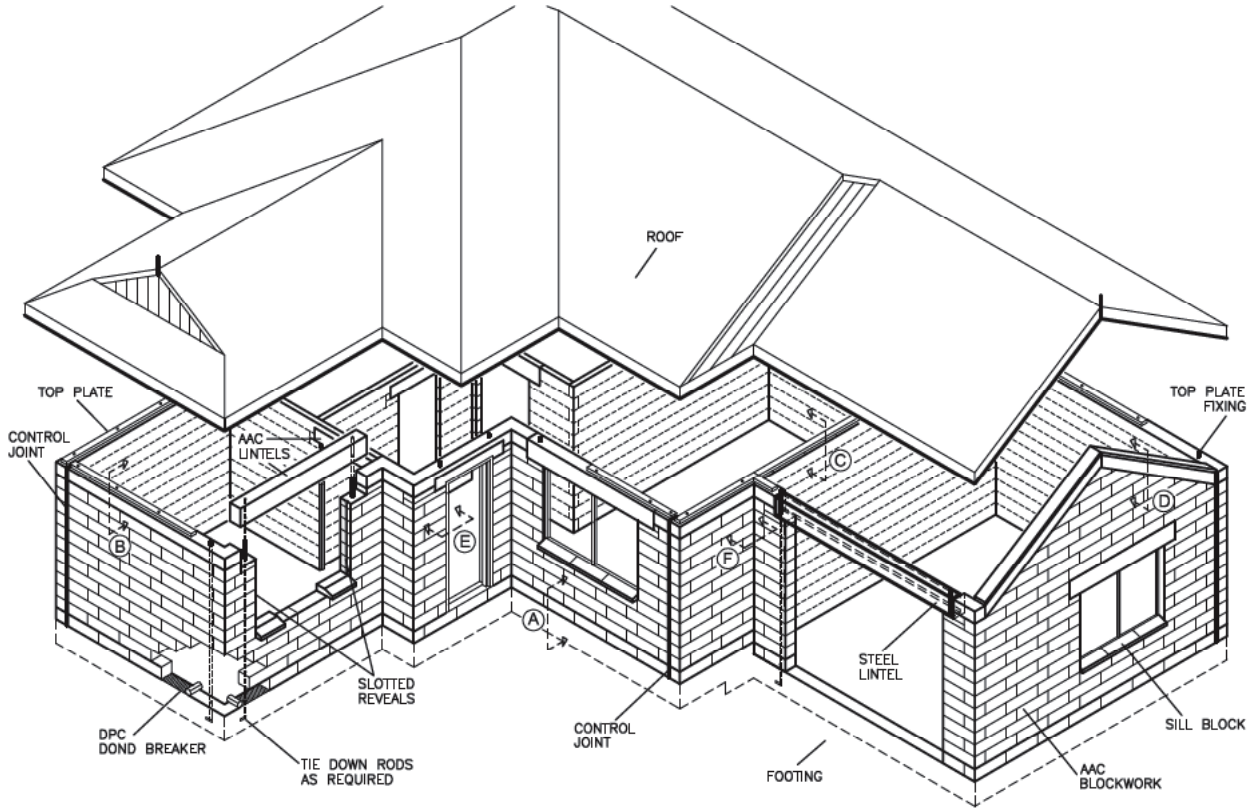

DETAIL 1.0 - ISOMETRIC CONCEPT HOUSE

Section 6

SECTION DETAIL REFERENCES	
A=2.1	D=6.6
B=6.7	E=7.2
C=6.2	F=4.2

DETAIL 2.1 – HEBEL BLOCKWORK ON STIFFENED RAFT SLAB EDGE FOUNDATION

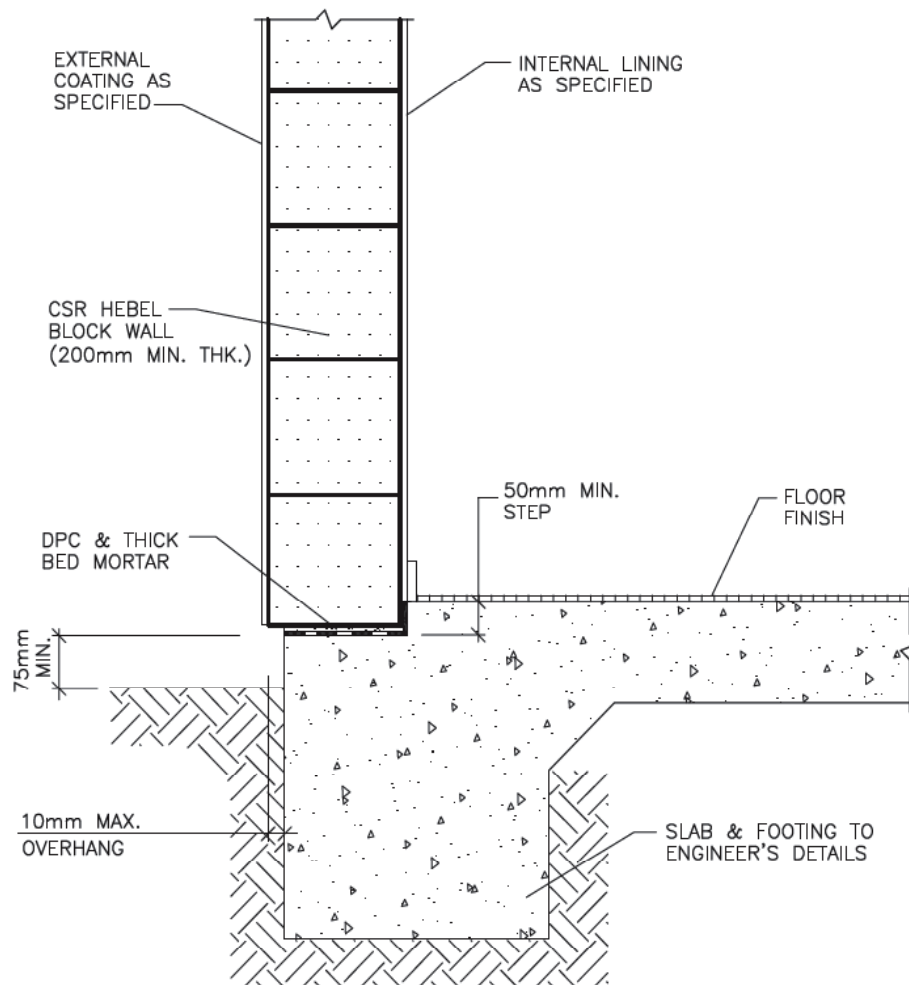

DETAIL 2.2 – INTERNAL LOAD BEARING HEBEL BLOCKWORK
ON STIFFENED RAFT SLAB FOUNDATION

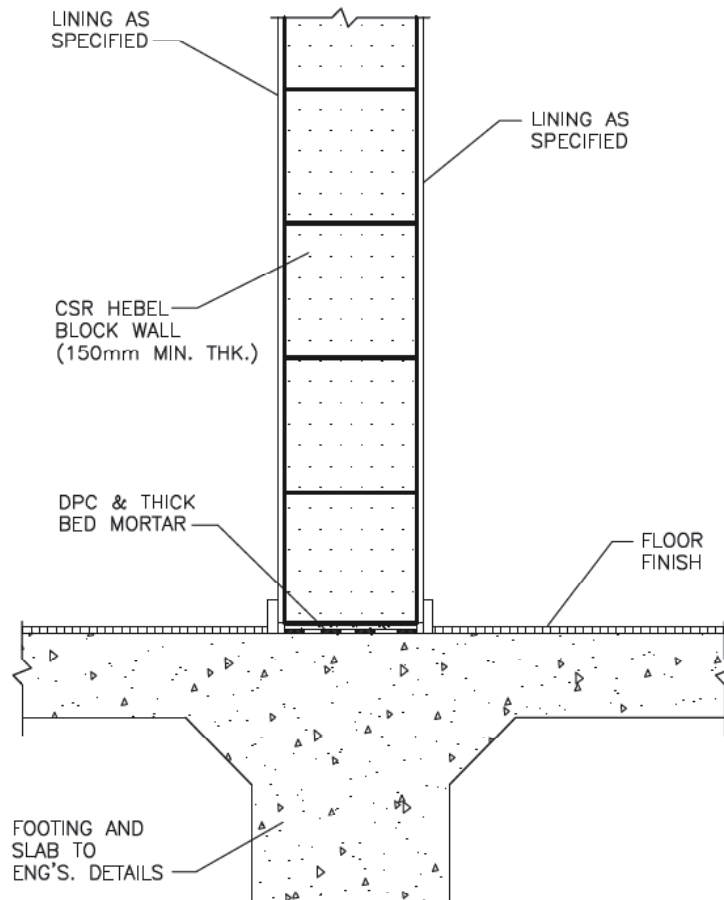

DETAIL 3.1 – HEBEL BLOCKWORK TYPICAL MOVEMENT JOINT DETAIL – ELEVATION VIEW

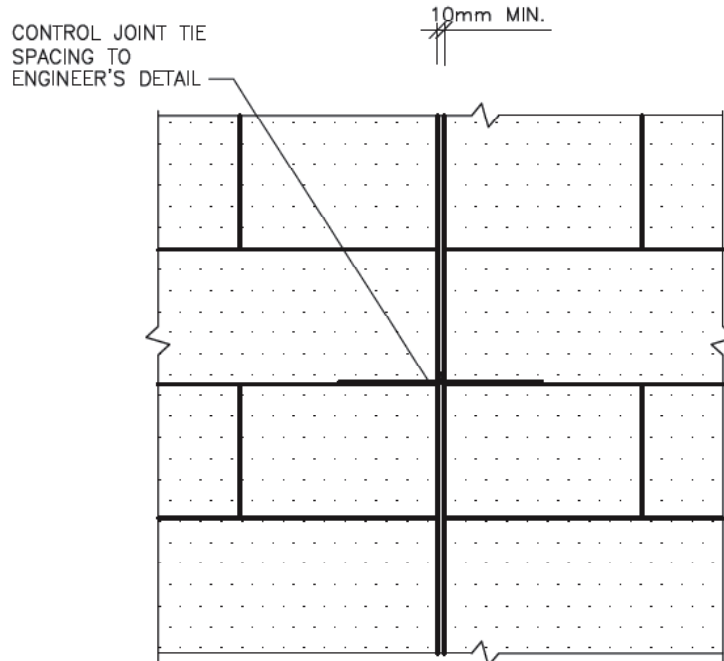

DETAIL 3.1.1 – HEBEL BLOCKWORK TYPICAL MOVEMENT JOINT DETAIL – PLAN VIEW

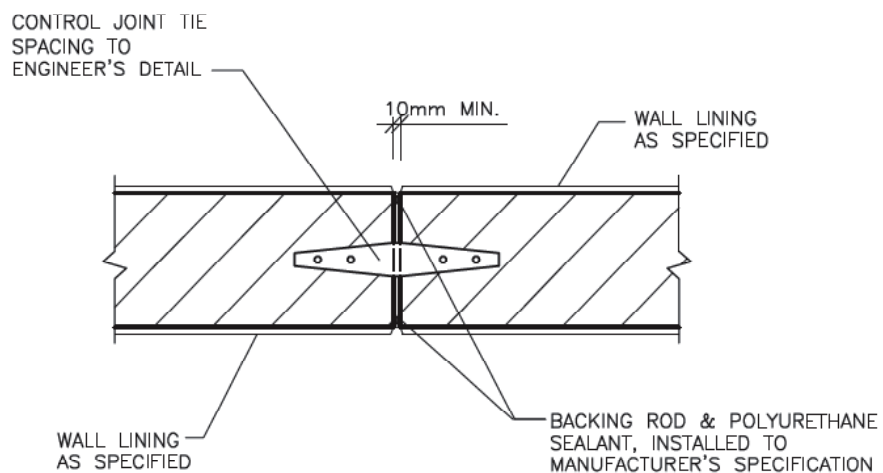

DETAIL 3.2 – HEBEL BLOCKWORK MOVEMENT JOINT DETAIL – ELEVATION VIEW

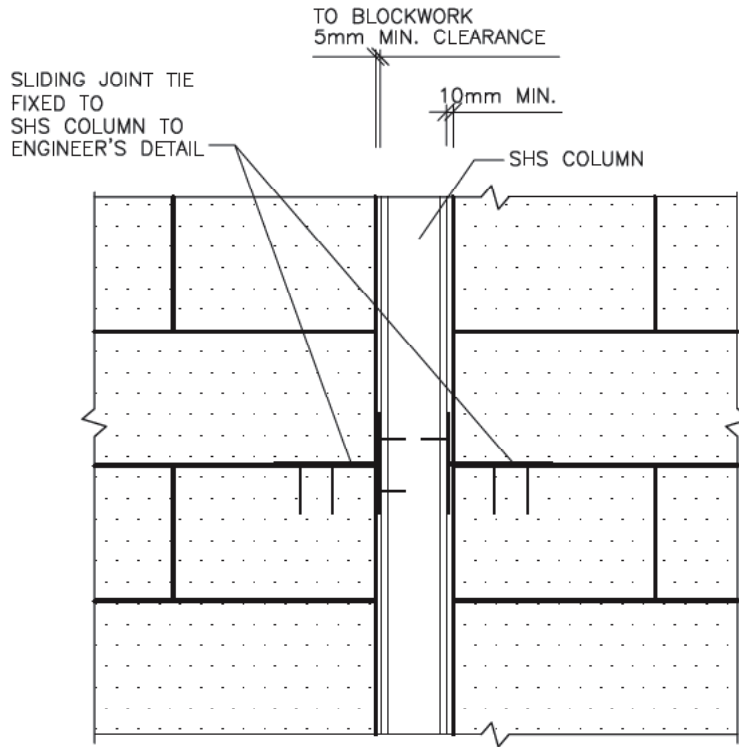

DETAIL 3.2.1 – HEBEL BLOCKWORK MOVEMENT JOINT DETAIL – PLAN VIEW

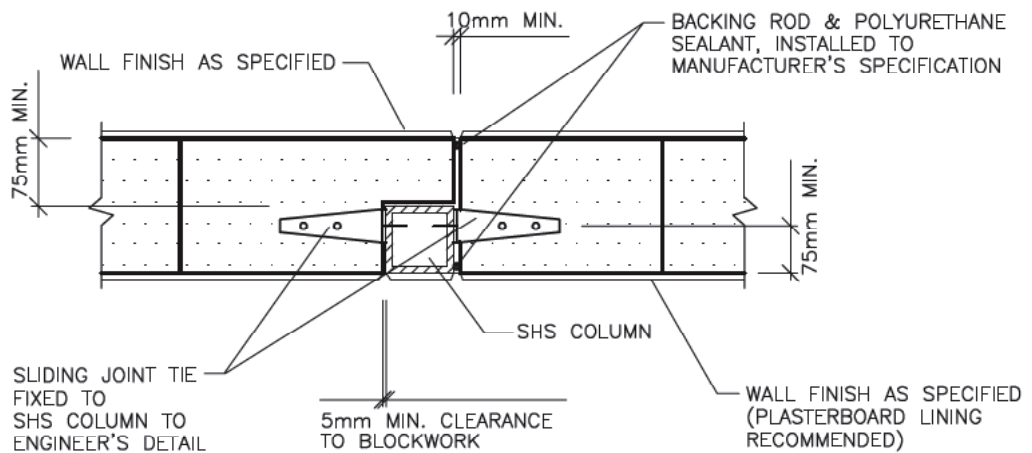

DETAIL 4.1 – EXTERNAL WALL AND INTERNAL BRACING WALL JUNCTION – PLAN VIEW

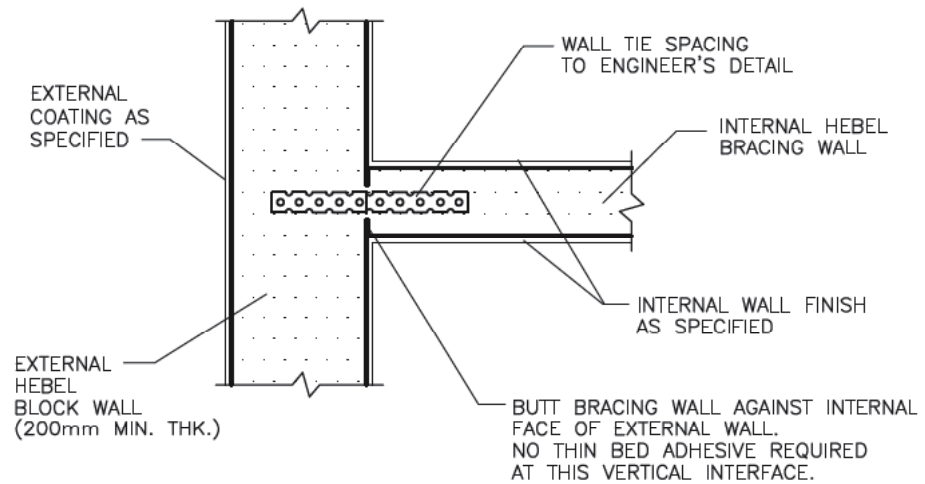

DETAIL 4.2 – EXTERNAL WALL AND INTERNAL WALL JUNCTION – PLAN VIEW

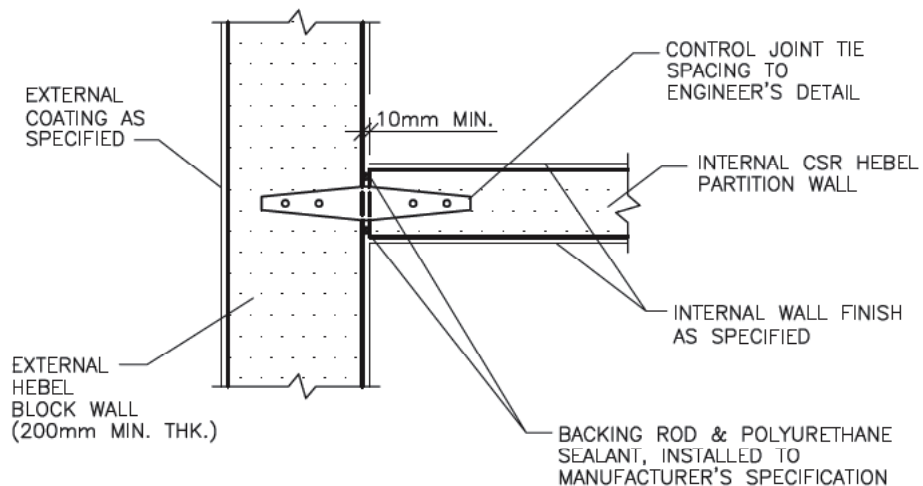

DETAIL 4.3 – EXTERNAL WALL AND INTERNAL BRACING WALL JUNCTION – PLAN VIEW

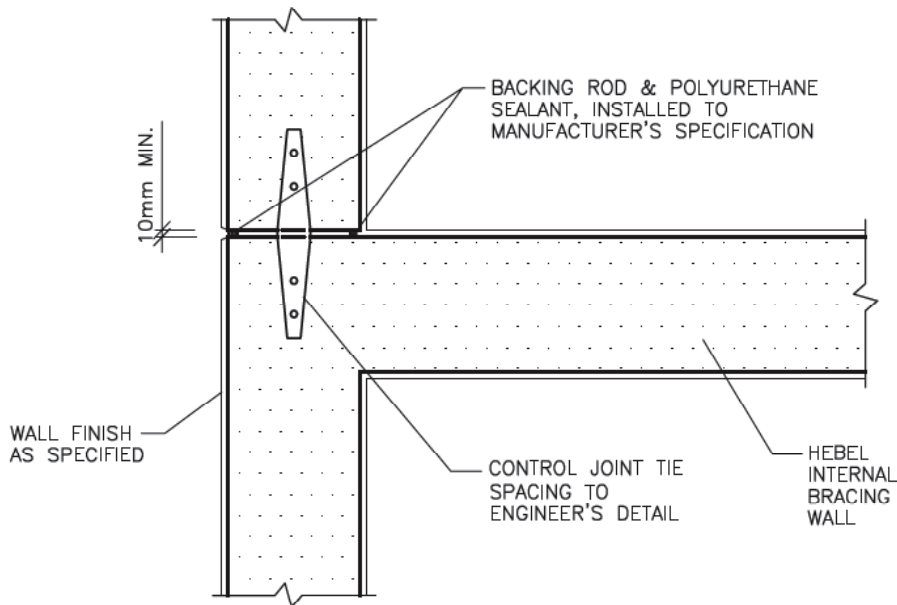

DETAIL 4.4 – EXTERNAL WALL AND INTERNAL TIMBER/STEEL STUD WALL JUNCTION – PLAN VIEW

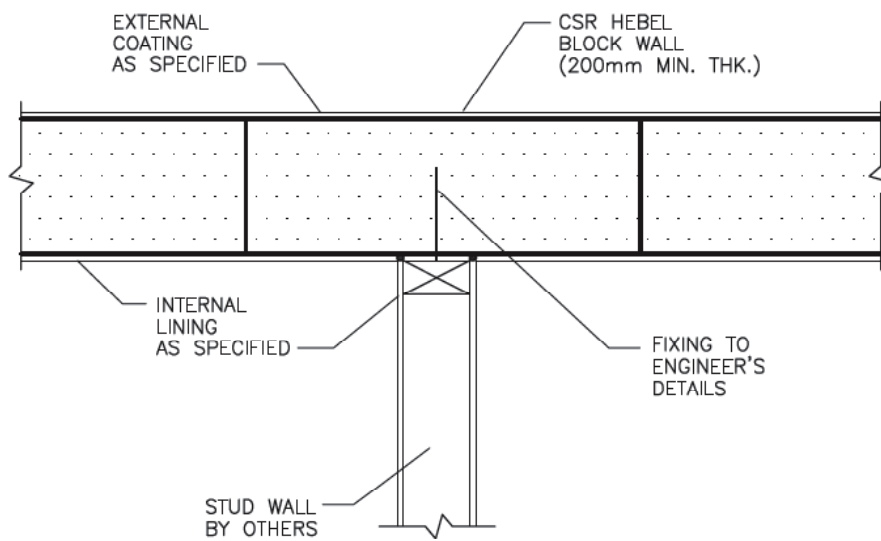

DETAIL 4.5 – HEBEL BLOCKWORK AND CONCRETE WALL/COLUMN JUNCTION – PLAN VIEW

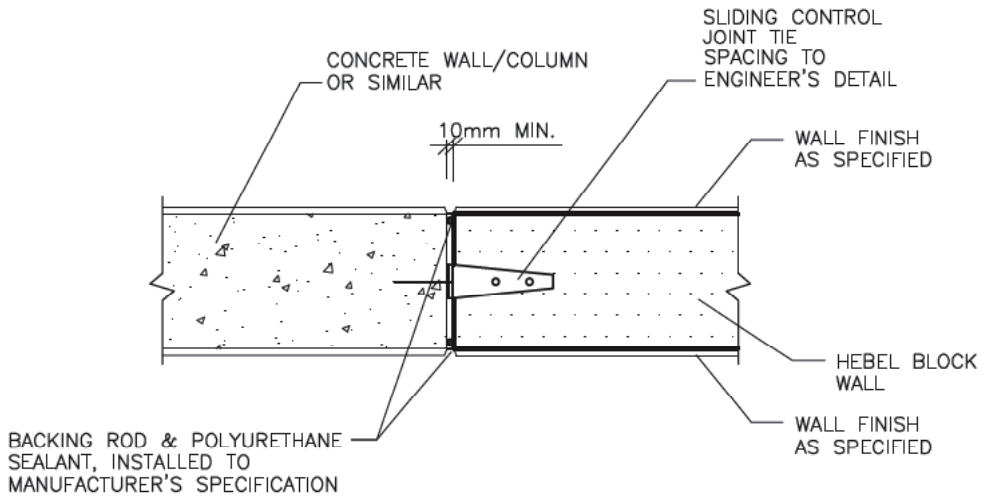

DETAIL 4.6 – NON LOAD BEARING HEBEL BLOCK WALL AND BEAM/SLAB JUNCTION

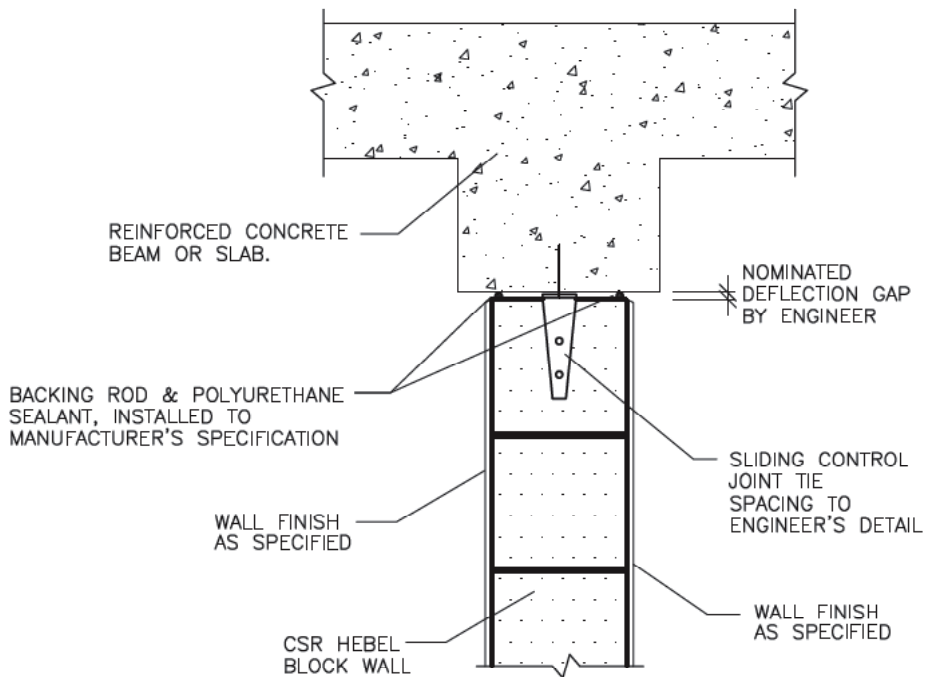

Section 6

DETAIL 5.1 – HEBEL BLOCK WALL AND FLOOR PANEL JUNCTION DETAIL

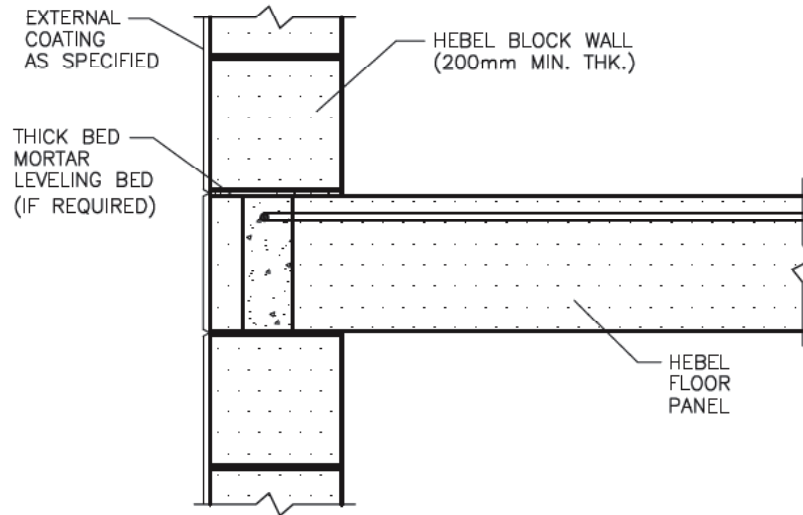

NOTE: WHERE THE FLOOR SYSTEM IS CONSIDERED A DIAPHRAGM, THE ENGINEER SHALL DETERMINE IF THE RING ANCHOR REINFORCEMENT SIZE & ANCHORAGE IS ADEQUATE.

DETAIL 5.2 – HEBEL BLOCK WALL AND TIMBER FLOOR FRAME JUNCTION

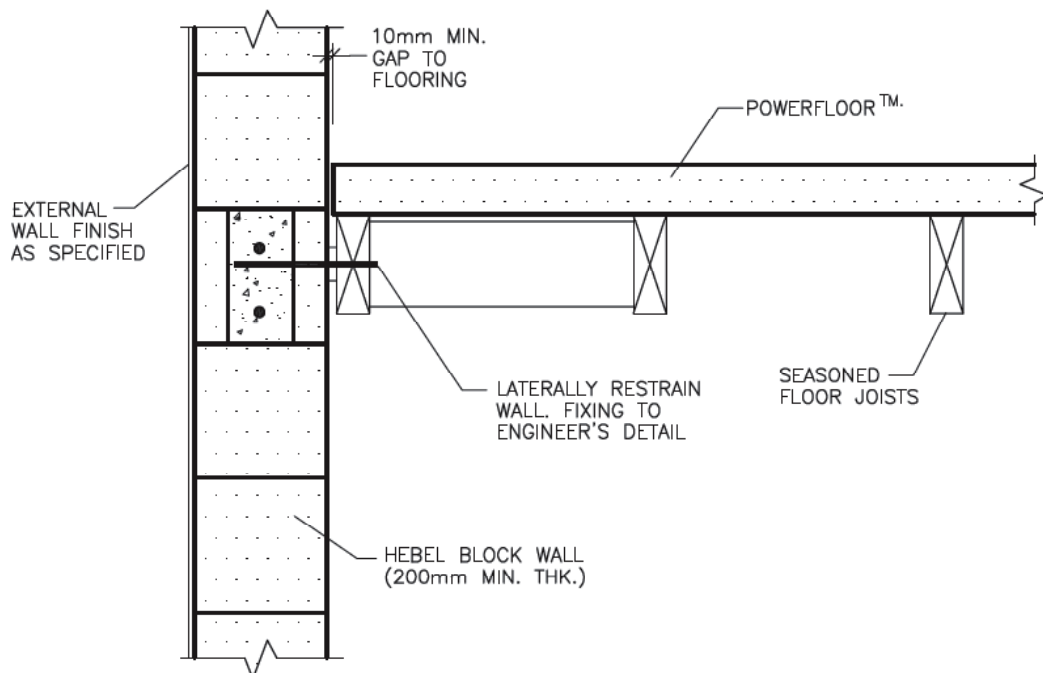

DETAIL 5.3 – INTERNAL HEBEL WALL AND TIMBER FLOOR FRAME JUNCTION

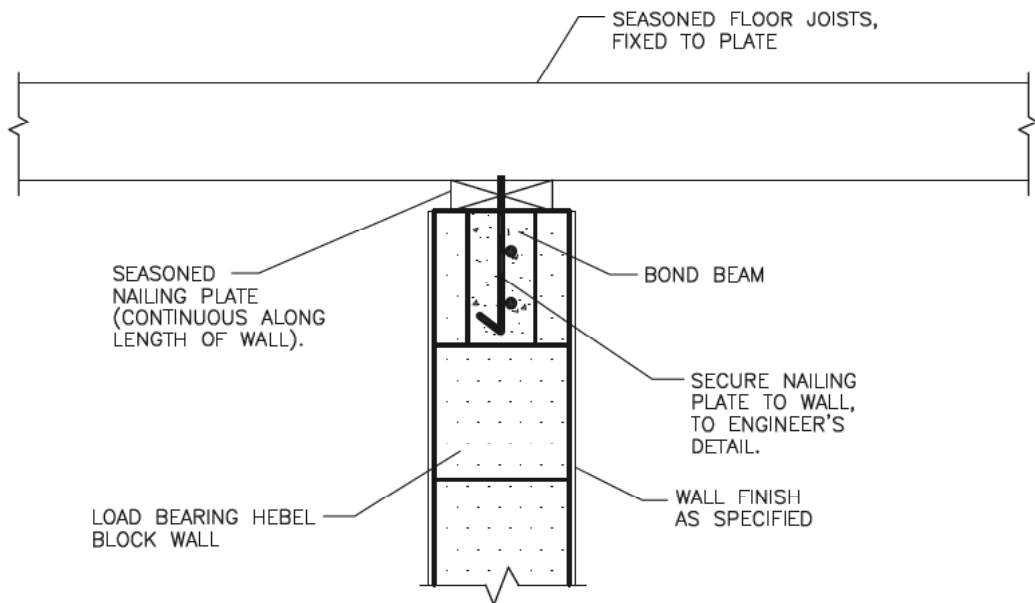

DETAIL 5.4 – EXTERNAL HEBEL WALL AND REINFORCED CONCRETE SLAB JUNCTION

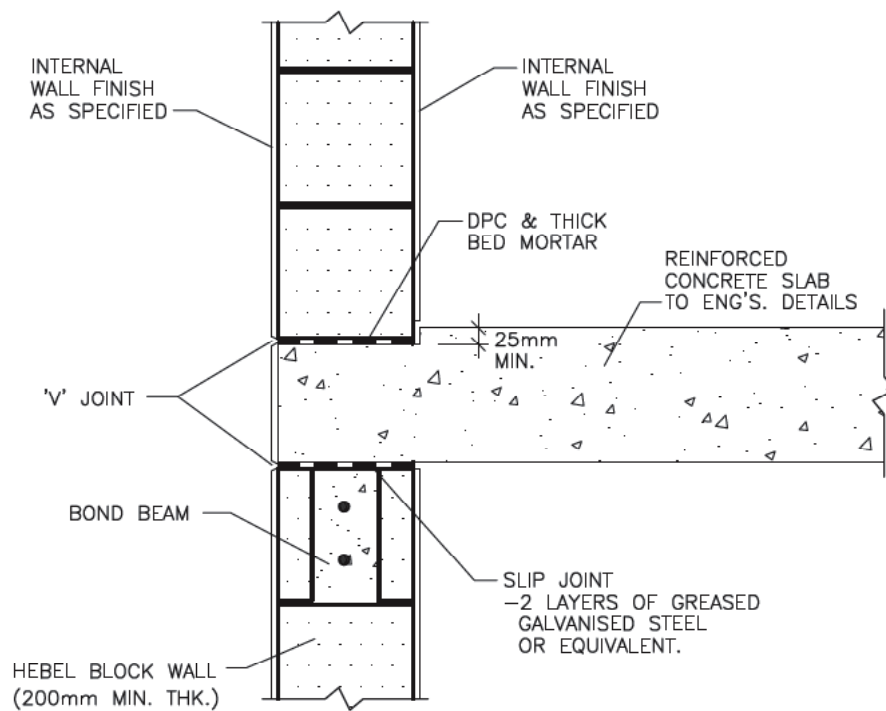

Section 6

DETAIL 6.1 – ROOF TOP PLATE FIXING TO HEBEL WALL

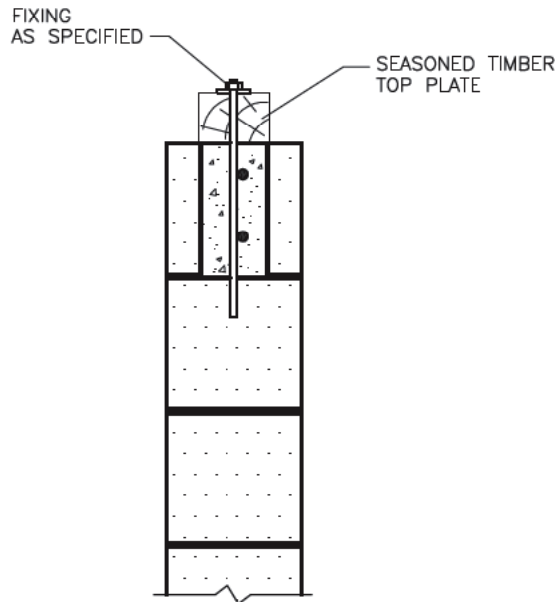

NOTE:
FIXING & ROD SPACING AS DETAILED BY ENGINEER

DETAIL 6.2 – TRUSS SPANNING OVER NON-LOAD BEARING HEBEL WALLS

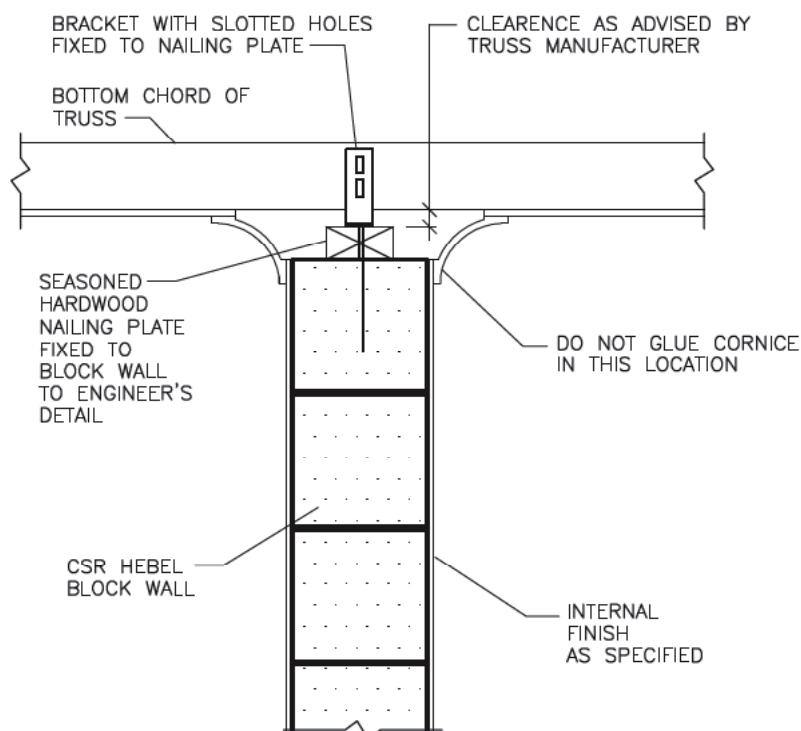

DETAIL 6.3 – ROOF TOP PLATE FIXING TO HEBEL WALL

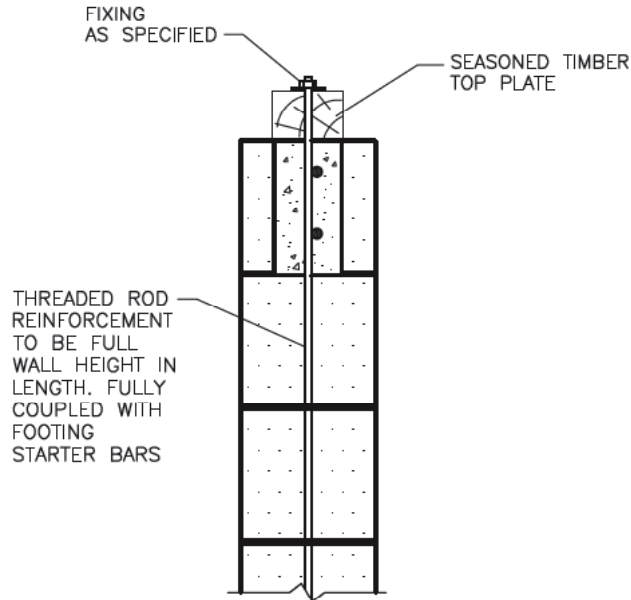

NOTE:
FIXING, ROD SIZE & SPACING AS DETAILED BY ENGINEER

DETAIL 6.4 – TIMBER TRUSS/JOIST FIXED TO HEBEL WALL

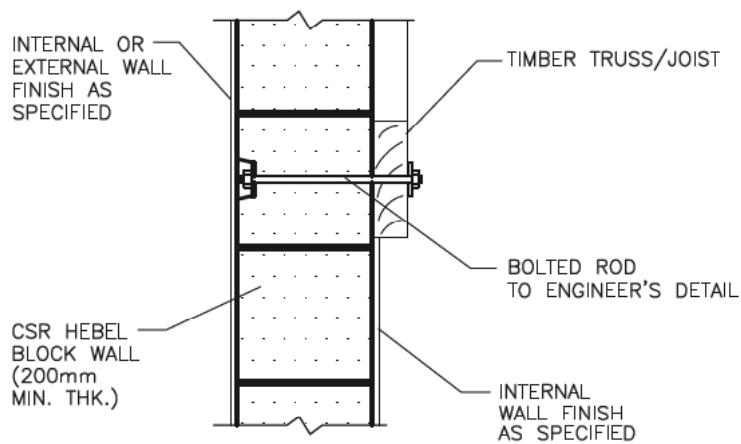

DETAIL 6.5 – VAULTED CEILING & ROOF TOP PLATE FIXING TO HEBEL WALL

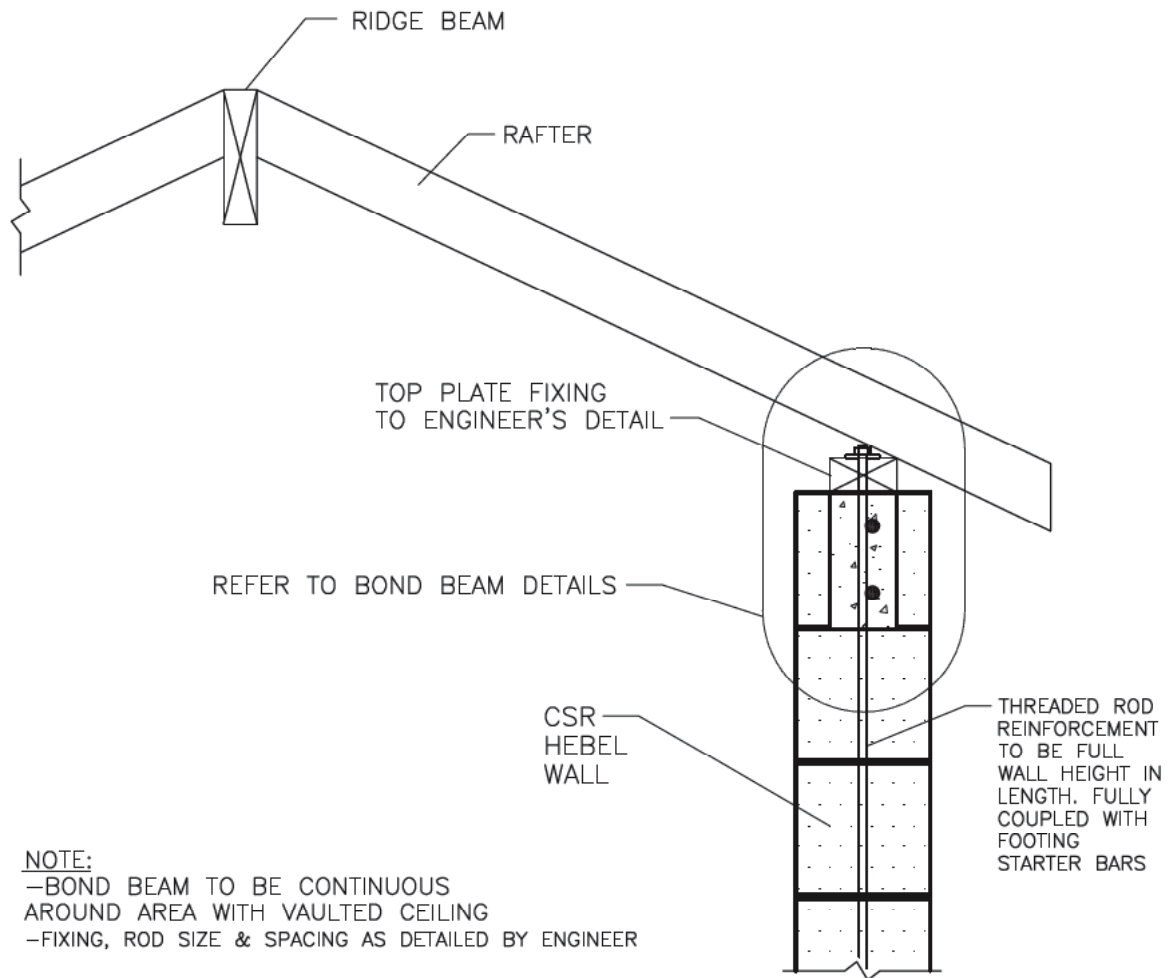

DETAIL 6.6 – GABLE END ROOF FIXING TO HEBEL WALL

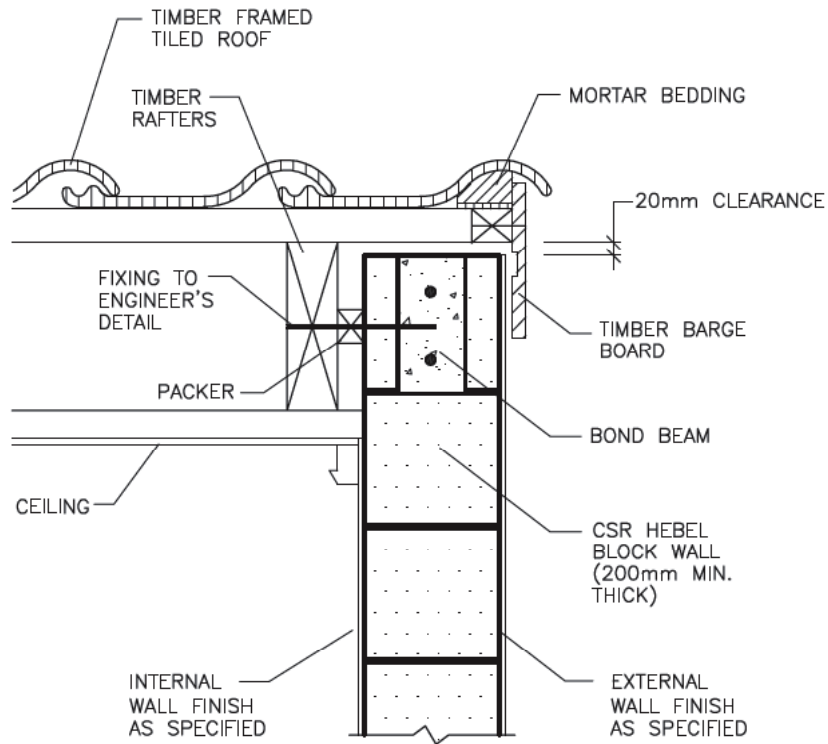

SECTION 1
SCALE N.T.S.

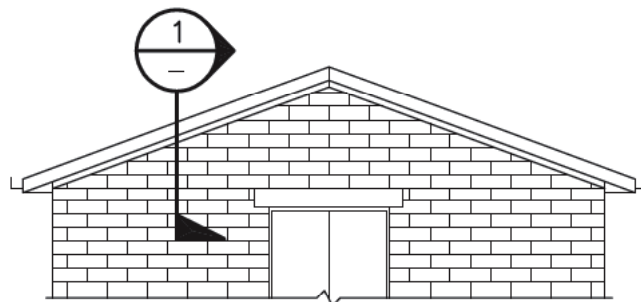

ELEVATION -
SCALE N.T.S.

Section 6

DETAIL 6.7 – TILED ROOF EVE AND HEBEL WALL JUNCTION

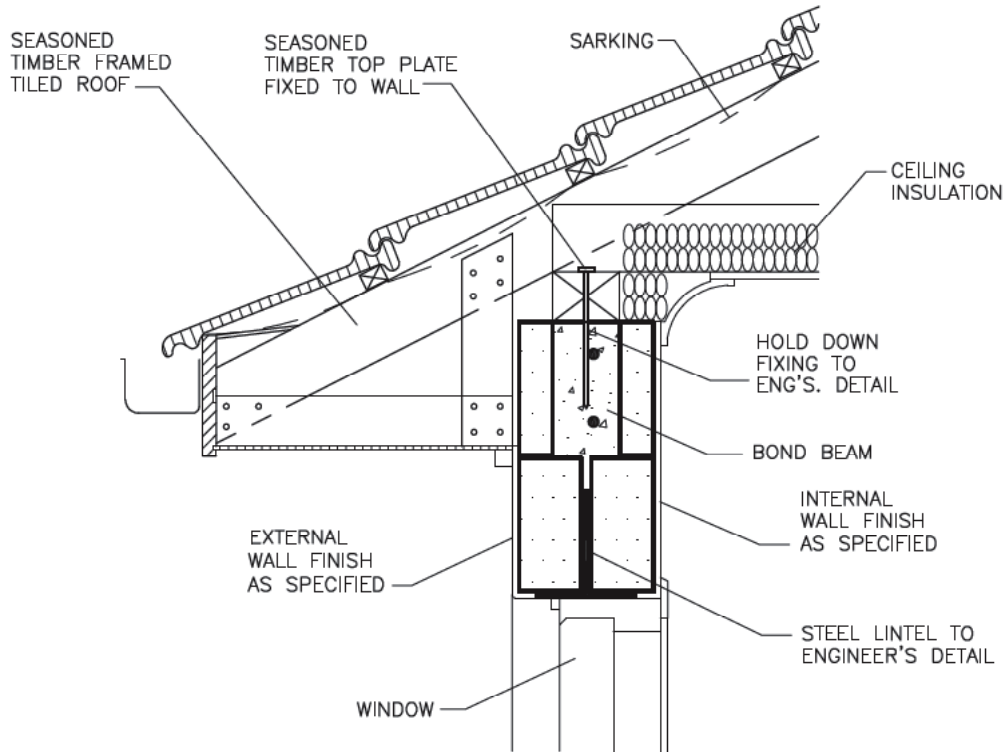

NOTE:
POSITION OF TOP PLATE
AND TYPE OF HOLD DOWN
TO ENGINEER'S DETAIL

DETAIL 6.8 – TIMBER AWNING AND HEBEL WALL JUNCTION

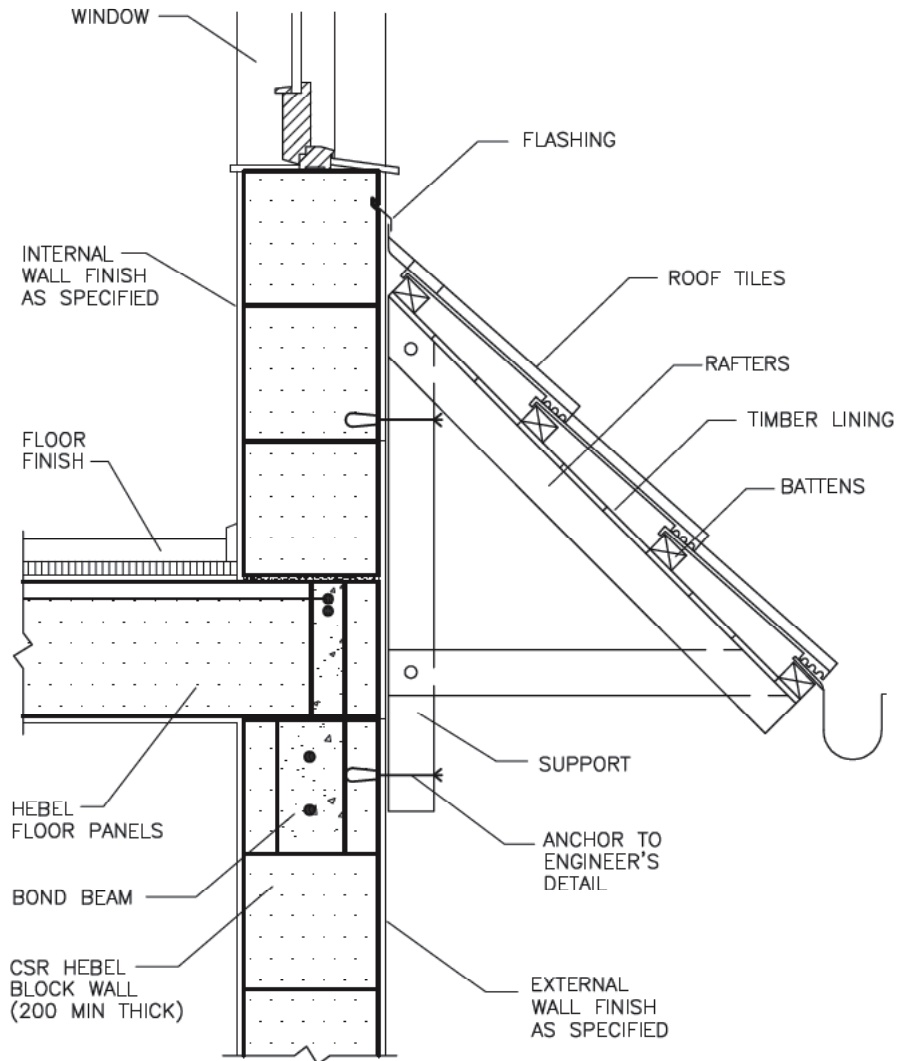

DETAIL 7.1 – STEEL DOOR FRAME (INTERNAL OR EXTERNAL) TO HEBEL WALL FIXING

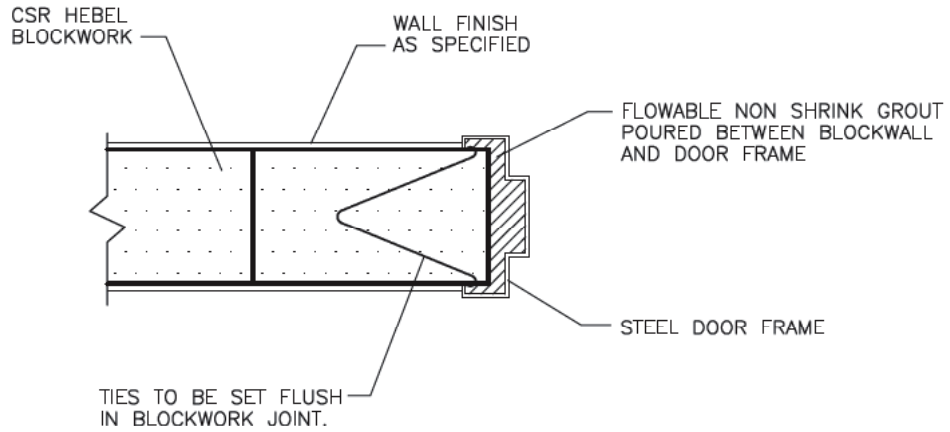

NOTE:
REFER TO DOOR FRAME MANUFACTURER FOR CONSTRUCTION DETAILS

DETAIL 7.2 – STEEL DOOR FRAME (INTERNAL OR EXTERNAL) TO HEBEL WALL FIXING

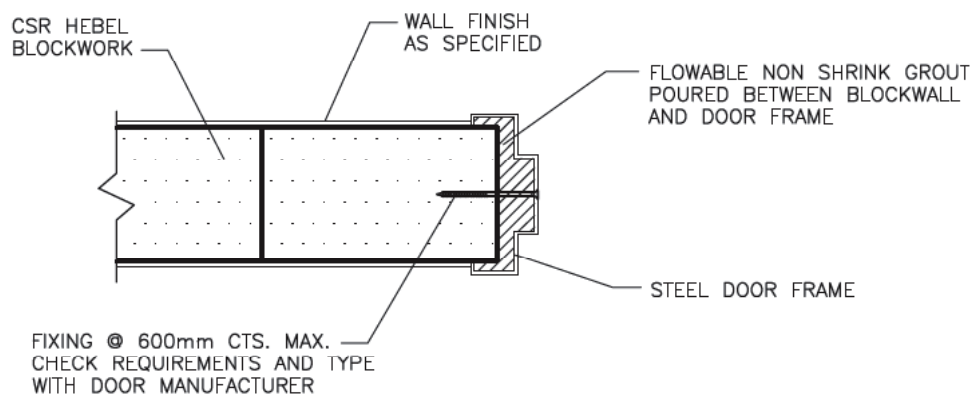

NOTE:
REFER TO DOOR FRAME MANUFACTURER FOR CONSTRUCTION DETAILS

DETAIL 7.3 – TIMBER DOOR FRAME (EXTERNAL) TO HEBEL WALL FIXING

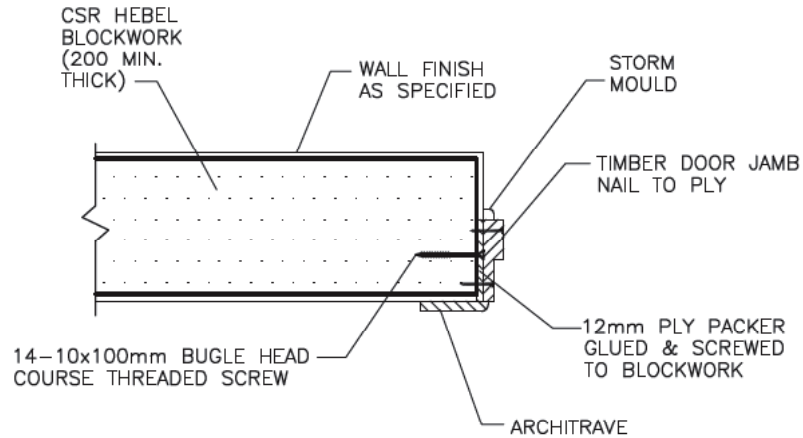

DETAIL 7.4 – TIMBER DOOR FRAME (INTERNAL) TO HEBEL WALL FIXING

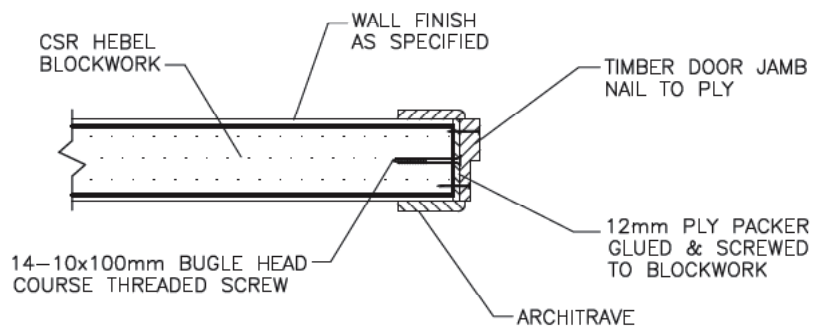

DETAIL 7.5 – ALUMINIUM WINDOW FRAME – WINDOW SILL DETAIL

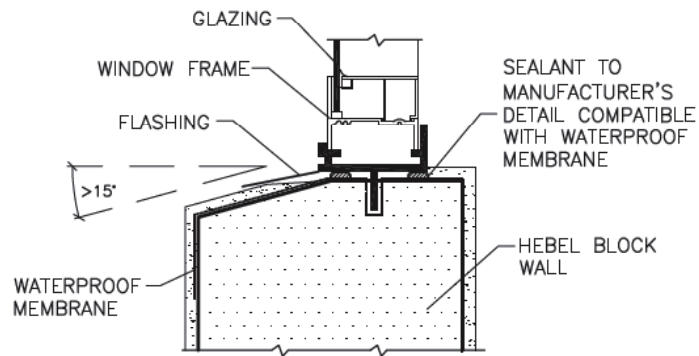

DETAIL 7.6 – ALUMINIUM WINDOW FRAME – WINDOW SIDE DETAIL

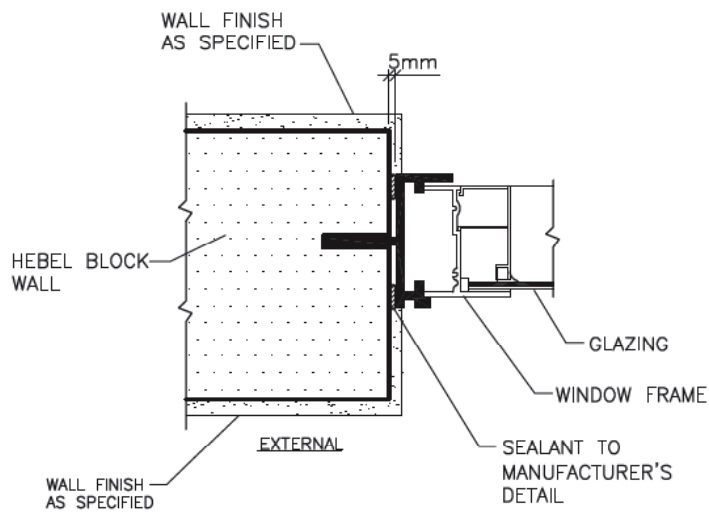

DETAIL 7.7 – ALUMINIUM WINDOW FRAME – WINDOW HEAD DETAIL

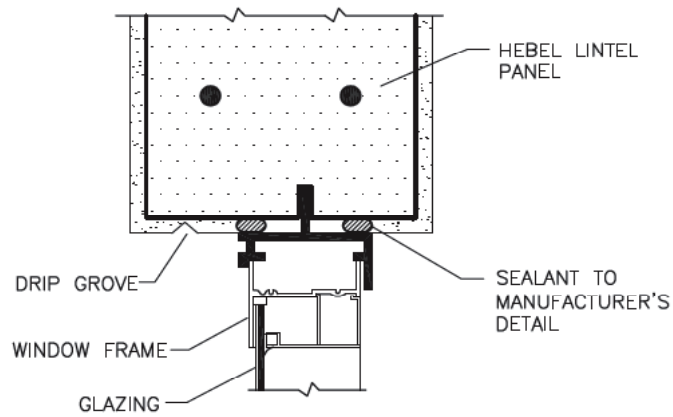

DETAIL 7.8 – TIMBER WINDOW FRAME – WINDOW SILL DETAIL

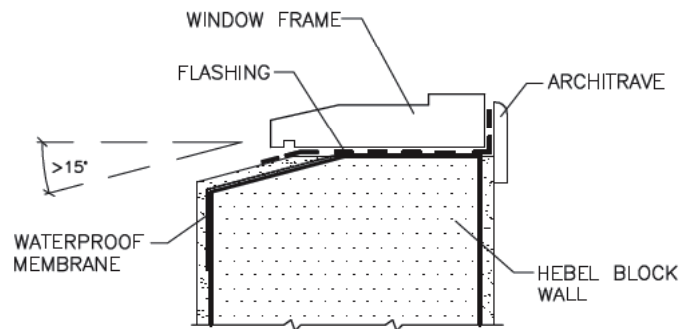

DETAIL 7.9 – TIMBER WINDOW FRAME – SIDE FRAME DETAIL

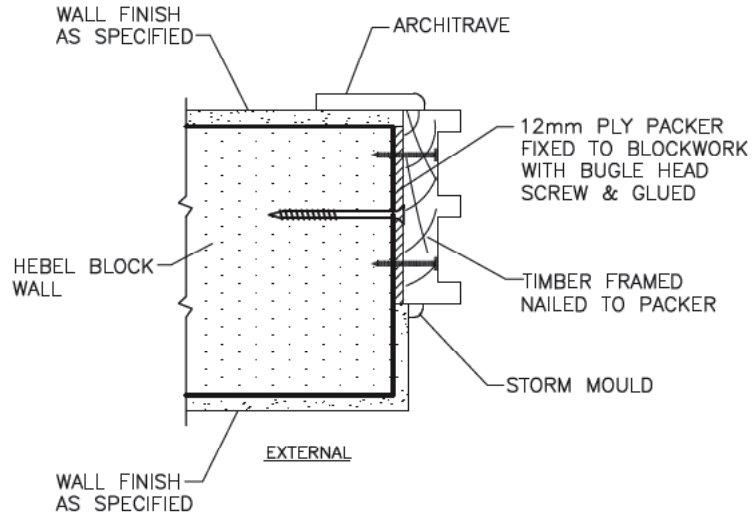

NOTE:
KEEP PACKER 100mm CLEAR OF THE FRAME CORNERS. FILL THE GAPS WITH EXPANDING FOAM.

DETAIL 7.10 – TIMBER WINDOW FRAME – WINDOW HEAD DETAIL

